

INSTRUCTION MANUAL

Tabletop Vacuum Packaging

Item	59006	59007	59008	59009	59010
Model	VP-NL-0004-SN	VP-NL-0008-SN	VP-NL-0016-SN	VP-NL-0021-SN	VP-NL-0016-LN



Warning!

Before you begin using your appliance, **PLEASE READ AND UNDERSTAND THIS DOCUMENT CAREFULLY** before installing, operating, maintaining, or servicing.

There are many important safety messages in this manual and on your appliance. Always read all safety messages.

Failure to do so can result in appliance failure, property damage, serious injury or death. Appliance failure, injury or property damage due to improper installation is not covered by warranty.

Stop!

DO NOT RETURN THIS PRODUCT TO THE STORE!

For questions or assistance with this product, call TRENTO Toll free: **1-800-465-0234** or visit the support section from our website, **www.trentoequipment.com**

Version: Revised - 03/22/2024



TABLE OF CONTENTS

Section	Page
General Information -----	3 - 4
Safety and Warranty -----	4 - 5
Technical Specifications -----	6
Installation -----	6 - 7
Operation -----	7 - 15
Maintenance -----	15 - 19
Troubleshooting -----	19 - 21
Parts Breakdown -----	22 - 44
Electrical Schematics -----	45 - 46
Warranty Registration -----	47

GENERAL INFORMATION

Omcan Manufacturing and Distributing Company Inc., Food Machinery of America, Inc. dba Omcan and Omcan Inc. are not responsible for any harm or injury caused due to any person's improper or negligent use of this equipment. The product shall only be operated by someone over the age of 18, of sound mind, and not under the influence of any drugs or alcohol, who has been trained in the correct operation of this machine, and is wearing authorized, proper safety clothing. Any modification to the machine voids any warranty, and may cause harm to individuals using the machine or in the vicinity of the machine while in operation.

CHECK PACKAGE UPON ARRIVAL

Upon receipt of an Omcan shipment please inspect for external damage. If no damage is evident on the external packaging, open carton to ensure all ordered items are within the box, and there is no concealed damage to the machine. If the package has suffered rough handling, bumps or damage (visible or concealed), please note it on the bill of lading before accepting the delivery and contact Omcan within 24 hours, so we may initiate a claim with the carrier. A detailed report on the extent of the damage caused to the machine must be filled out within three days, from the delivery date shown in the shipping documents. Omcan has no recourse for damaged products that were shipped collect or third party.

Before operating any equipment, always read and familiarize yourself with all operation and safety instructions.

Omcan would like to thank you for purchasing this machine. It's of the utmost importance to save these instructions for future reference. Also save the original box and packaging for shipping the equipment if servicing or returning of the machine is required.

Omcan Fabrication et distribution Compañie Limité et Food Machinery d'Amérique, dba Omcan et Omcan Inc. ne sont pas responsables de tout dommage ou blessure causé du fait que toute personne ait utilisé cet équipement de façon irrégulière. Le produit ne doit être exploité que par quelqu'un de plus de 18 ans, saine d'esprit, et pas sous l'influence d'une drogue ou d'alcool, qui a été formé pour utiliser cette machine correctement, et est vêtu de vêtements de sécurité approprié. Toute modification de la machine annule toute garantie, et peut causer un préjudice à des personnes utilisant la machine ou des personnes à proximité de la machine pendant son fonctionnement.

VÉRIFIEZ LE COLIS DÈS RÉCEPTION

Dès réception d'une expédition d'Omcan veuillez inspecter pour dommages externes. Si aucun dommage n'est visible sur l'emballage externe, ouvrez le carton afin de s'assurer que tous les éléments commandés sont dans la boîte, et il n'y a aucun dommage dissimulé à la machine. Si le colis n'a subi aucune mauvaises manipulations, de bosses ou de dommages (visible ou cachée), notez-le sur le bond de livraison avant d'accepter la livraison et contactez Omcan dans les 24 heures qui suivent, pour que nous puissions engager une réclamation auprès du transporteur. Un rapport détaillé sur l'étendue des dommages causés à la machine doit être rempli dans un délai de trois jours, à compter de la date de livraison indiquée dans les documents d'expédition. Omcan n'a aucun droit de recours pour les produits endommagés qui ont été expédiées ou cueilli par un tiers transporteur.

Avant d'utiliser n'importe quel équipement, toujours lire et vous familiariser avec toutes les opérations et les

GENERAL INFORMATION

consignes de sécurité.

Omcan voudrais vous remercier d'avoir choisi cette machine. Il est primordial de conserver ces instructions pour une référence ultérieure. Également conservez la boîte originale et l'emballage pour l'expédition de l'équipement si l'entretien ou le retour de la machine est nécessaire.

Omcan Empresa De Fabricacion Y Distribucion Inc. Y Maquinaria De Alimentos De America, Inc. dba Omcan y Omcan Inc. no son responsables de ningun daño o perjuicio causado por cualquier persona inadecuada o el uso descuidado de este equipo. El producto solo podra ser operado por una persona mayor de 18 años, en su sano juicio y no bajo alguna influencia de droga o alcohol, y que este ha sido entrenado en el correcto funcionamiento de esta máquina, y ésta usando ropa apropiada y autorizada. Cualquier modificación a la máquina anula la garantía y puede causar daños a las personas usando la máquina mientras esta en el funcionamiento.

REVISE EL PAQUETE A SU LLEGADA

Tras la recepcion de un envio Omcan favor inspeccionar daños externos. Si no hay daños evidentes en el empaque exterior, Habra el carton para asegurarse que todos los articulos solicitados estén dentro de la caja y no encuentre daños ocultos en la máquina. Si el paquete ha sufrido un manejo de poco cuidado, golpes o daños (visible o oculto) por favor anote en la factura antes de aceptar la entrega y contacte Omcan dentro de las 24 horas, de modo que podamos iniciar una reclamación con la compañía. Un informe detallado sobre los daños causados a la máquina debe ser llenado en el plazo de tres días, desde la fecha de entrega que se muestra en los documentos de envío. Omcan no tiene ningun recurso por productos dañados que se enviaron a recoger por terceros.

Antes de utilizar cualquier equipo, siempre lea y familiarizarse con todas las instrucciones de funcionamiento y seguridad.

Omcan le gustaría darle las gracias por la compra de esta máquina. Es de la mayor importancia para salvar estas instrucciones para futuras consultas. Además, guarda la caja original y el embalaje para el envío del equipo si servicio técnico o devolución de la máquina que se requiere.

SAFETY AND WARRANTY

The manufacturer of this equipment accepts no liability whatsoever for damage or injury caused by failing to adhere to the directions and instructions in this manual, or through carelessness during the installation, use, maintenance and repair of the machine identified on the front of this document, or any of its accompanying options or components.

The owner of the machine is fully responsible at all times for the adherence to the locally applicable safety regulations and guidelines. Obey all safety instructions and guidelines as provided in this manual.

SAFETY AND WARRANTY

INTENDED USE OF THE MACHINE

The machine is designed for vacuum packaging of food or other products for 8 hours a day, 5 days a week. Any other or extended use is not in accordance with this purpose and the manufacturer accepts no liability for any resulting damage or injury. Only use this machine while in perfect technical condition in accordance with the above mentioned purpose.

Safety Measures

The machine is equipped with the following standard safety devices:

- Short-circuit and overload safety.
- Pump fan guards.

All safety devices must be correctly installed and may only be removed to accommodate maintenance and repair activities by trained and authorized service personnel. The machine may never be operated while safety measures are incomplete, deactivated or absent. The safety devices may never be by-passed.

RESIDENTIAL USERS: vendor assumes no liability for parts or labor coverage for component failure or other damages resulting from installation in non-commercial or residential applications. The right is reserved to deny shipment for residential usage; if this occurs, you will be notified as soon as possible.

1 YEAR PARTS AND LABOR WARRANTY

Within the warranty period, contact Omcan Inc. at 1-800-465-0234 to schedule an Omcan authorized service technician to repair the equipment locally.

Unauthorized maintenance will void the warranty. Warranty covers electrical and part failures, not improper use.

Please see <https://omcan.com/disclaimer> for complete info.

WARNING:

The packaging components are classified as normal solid urban waste and can therefore be disposed of without difficulty.

In any case, for suitable recycling, we suggest disposing of the products separately (differentiated waste) according to the current norms.

DO NOT DISCARD ANY PACKAGING MATERIALS IN THE ENVIRONMENT!

TECHNICAL SPECIFICATIONS

11" VACUUM PACKAGING MACHINES

Item Number	59006	59007
Model	VP-NL-0004-SN	VP-NL-0008-SN
Seal Length	11" / 280mm	
Vacuum Pump	4 m ³	8 m ³
10 Programmable Control	No	
Maximum Product Height	4.3" / 110mm	
Useful Chamber Size	12.2" x 11" x 4.3" / 310 x 279 x 110mm	
Power Consumption	0.4 - 0.5 kW	
Electrical	110-120V / 60Hz / 1	
Net Weight	55.1 lbs. / 25 kgs.	
Net Dimensions (DWH)	19.7" x 14.4" x 13.4" / 500 x 365 x 340mm	

16.5" VACUUM PACKAGING MACHINES

Item Number	59008	59009	59010
Model	VP-NL-0016-SN	VP-NL-0021-SN	VP-NL-0016-LN
Seal Length	16.5" / 420mm		
Vacuum Pump	16 m ³	21 m ³	16 m ³
10 Programmable Control	No	Yes	No
Maximum Product Height	7.1" / 180mm		
Useful Chamber Size	14.6" x 16.5" x 7" / 370 x 420 x 178mm		
Power Consumption	0.7 - 1.3 kW		
Electrical	110-120V / 60Hz / 1		
Net Weight	132.3 lbs. / 60 kgs.		
Net Dimensions (DWH)	21.9" x 20.7" x 18.1" / 555 x 525 x 460mm		

INSTALLATION

GENERAL

- Level the machine on a flat firm surface.

INSTALLATION

- Position the machine in such a manner that the pump is unobstructed and properly ventilated.
- Engage the locks on the wheels, if so equipped.
- Check the oil level in the pump; add oil if necessary.

Never operate the machine when the oil level is low. It is recommended to change the oil at least every 2 months.

TURNING ON MACHINE

- If so equipped, like some mobile and double-chamber models, turn on the main power switch on the back of the machine.
- Push the on/off button on the control panel of the machine.

GAS CONNECTION FOR MAP APPLICATIONS (MODIFIED ATMOSPHERIC PACKAGING)

- Connect the gas supply line to the inlet on the back of the machine.
- Maximum pressure: 1 bar.
- Anchor the gas cylinders securely to prevent them from falling over.
- Make sure that the work area is well-ventilated.
- To assure that you use the appropriate gas for your application, consult your dealer or gas supplier.
- Assure a good connection and use high-quality materials.

COMPRESSED AIR CONNECTION FOR ADDITIONAL SEALING PRESSURE

- Additional sealing pressure is usually recommended for MAP applications only.
- The M40-M80 and the L10-L60 models with the option gas/MAP are standard equipped with a compressed air inlet.
- Extra sealing pressure is not necessary and not available for the Table-Top, M10, M20, M30.
- Consult your dealer for installation details.
- Maximum pressure: 1 bar.
- Assure a good connection and use high-quality connector.

OPERATION

DIGITAL CONTROL WITH LCD DISPLAY

Some Henkovac vacuum machines have a control system with just one program (P1). Other machines have an optional expanded control system, which can accommodate up to 9 custom programs (P1-9).

ONE-PROGRAM CONTROL SYSTEM

Henkovac machines with the one-program control system can be programmed for the following 2 functions:

1. Vacuum time (seconds).
2. Sealing time (seconds).













OPERATION

- The values for vacuum and sealing times are selected by the user and saved in program P1.
- During operation, the LCD display will show symbols to indicate the active function and the progress of the packing cycle.
- The actual vacuum pressure is indicated by the analog vacuum gauge.













PLUG AND PLAY

- When turning on the machine for the first time:
 - Running time of the vacuum pump is pre-set at 30-40 seconds and the sealing time at 2 seconds. Vacuum is indicated on the analog vacuum gauge.
- When turning on the machine after that, program P1 will contain the most-recently used settings.
- The vacuum and sealing times are easily adjusted to match the needs for the application.

OPERATING THE MACHINE WITH ONE-PROGRAM CONTROL SYSTEM

	<p>On: turns the machine on:</p> <ul style="list-style-type: none"> • The machine will start up in the most-recently used program. • The pump of a machine with a transparent cover will start when the cover is closed. <p>Off: turns the machine off:</p> <ul style="list-style-type: none"> • When pressing the  button once, the  symbol will start blinking and the pump will stop after about 4 seconds. • When pressing the  button a second time, the pump will stop immediately. • Closing the cover will initiate the cool-down phase; the machine will complete a number of vacuum cycles before turning off automatically.
	<p>Stop-function:</p> <ul style="list-style-type: none"> • Stops the machine at any point in the packing cycle and aerates the chamber. <p>Reset-function:</p> <ul style="list-style-type: none"> • While programming, resets the program value to its original setting. Press the menu button  to return to the home menu.
	<p>Stops the current function and initiates the next step in the cycle:</p> <ul style="list-style-type: none"> • By pressing the  of the sealing button  the vacuum function stops and the program jumps to the sealing function. • While packing sauce or soup, the package may be sealed as soon as product boiling is detected.
	<p>Entering the desired vacuum time </p> <p>By pressing the + or - of the vacuum button, the vacuum time can be increased or decreased.</p> <p>The selected value is confirmed and saved by pressing the menu button :</p> <ul style="list-style-type: none"> • Press the  button to reset the original value.

OPERATION

	<p>Entering the desired sealing time </p> <ul style="list-style-type: none"> By pressing the + or – of the sealing button, the sealing time can be increased or decreased. <p>The selected value is confirmed and saved by pushing the menu button :</p> <ul style="list-style-type: none"> Press the  button to reset the original value.
	<p>Menu button:</p> <ul style="list-style-type: none"> Confirms and saves the entered values for vacuum and sealing times. Returns to the home menu.
	<p>When turning off the machine with the , the  symbol will start blinking:</p> <ul style="list-style-type: none"> The pump will stop after about 4 seconds. Press the  button a second time and the pump will stop immediately. Close the lid; the machine initiates the cool-down phase and perform a number of vacuum cycles before turning off automatically. These additional cycles allow any moisture in the oil of the pump to evaporate. This increases the longevity of the machine and minimizes the need for oil changes and pump maintenance.
	<p>Service symbol:</p> <ul style="list-style-type: none"> After a number of operating hours or packing cycles, the service symbol will briefly appear on the display when the machine is turned on. In addition, the display indicates how many hours or cycles remain before an oil change is required. Except for regularly changing the oil in the pump (important!), the machine requires little other routine maintenance. To reset the service interval counters after the oil change: start machine  and while the display shows the hours or cycles, press and hold the  button.

TEN-PROGRAM CONTROL SYSTEM

In addition to vacuum and sealing times, Henkovac machines with a ten-program control system may be programmed for several additional functions. Each of the 9 customizable programs is either:

1. Time controlled.
2. Sensor controlled.

TIME-BASED OPERATION (VACUUM GAUGE: MBAR)

- The values for vacuum and sealing time, as well as the values for several optional functions, are selected by the customer and saved in any of 9 customizable programs P1-9.
- When operating a packaging machine with a time-based program, the actual vacuum pressure is indicated by the analog vacuum gauge. The number of seconds of vacuum time remaining is shown on the LCD display.

PLUG AND PLAY

- When turning on a time-based machine for the first time, it will start up in the PA program AUTOMATIC. This is a pre-set factory program with 30-40 seconds vacuum time and 2 seconds of sealing time.
- When turning on the machine after that, it will start up in the most-recently used program.

OPERATION

OPTIONAL INSTALLATION OF A SENSOR OR SOFT-AIR

- A machine with a time-based control program can be upgraded to sensor-based operation at a later date by installing the optional sensor kit.
- The soft-air feature can also be installed at a later date by ordering the optional soft-air kit.

SENSOR-BASED OPERATION (DIGITAL DISPLAY: MBAR)

- When operating a packaging machine with a sensor-based program, the actual vacuum pressure is digitally shown on the LCD display in mbar (standard setting) or in % vacuum.







PLUG AND PLAY

- When turning on a sensor-based machine for the first time, it will start up in the PA program AUTOMATIC. This is a pre-set factory program with 5 mbar of vacuum and 2 seconds of sealing time.
- When turning on the machine after that, it will start up in the most-recently used program.

























OPTIONAL INSTALLATION OF SOFT-AIR

- The soft-air feature can also be installed at a later date by ordering the optional soft-air kit.







OPERATING THE MACHINE WITH TEN-PROGRAM CONTROL SYSTEM

	<p>On: turns the machine on:</p> <ul style="list-style-type: none"> • The machine will start up in the most-recently used program. • The pump of a machine with a transparent cover will start when the cover is closed.
	<p>Off: turns the machine off:</p> <ul style="list-style-type: none"> • When pressing the  button once, the  symbol will start blinking and the pump will stop after about 4 seconds. • When pressing the  button a second time, the pump will stop immediately. • Closing the cover will initiate the cool-down phase. • The machine will complete a number of vacuum cycles before turning off automatically.
	<p>Stop-function:</p> <ul style="list-style-type: none"> • Stops the machine at any point in the cycle and aerates the chamber. <p>Reset-function:</p> <ul style="list-style-type: none"> • While programming, resets the program value to its original setting. • Press the menu button  to return to the home menu. <p>Back function:</p> <ul style="list-style-type: none"> • While reviewing programmed values, returns to the previous selection.
	<p>Stops the active function and initiates the next step in the cycle:</p> <ul style="list-style-type: none"> • While the machine is running, exits the active function and jumps to the next step in the cycle. • While packing sauce or soup, the package may be sealed as soon as product boiling is detected.

OPERATION

	<p>Menu button:</p> <ul style="list-style-type: none"> • Toggles between home menu  and settings menu  • Save function: during programming, confirms and saves the entered program values and returns to the home menu. • Return function: returns to the home menu.
	<p>Review program values:</p> <ul style="list-style-type: none"> •   Cycles through programs P1 to P9, as well as PA and P H2O. •  Displays the programmed value for each function; the function being reviewed will be blinking. •   Displays the value for the next function. •  Returns to the home menu.
	<p>Adjust program values and turn functions ON/OFF:</p> <ul style="list-style-type: none"> •   Forward or back; adjusted values are saved right away. •   Increases or decreases function values. •  Turns functions ON/OFF; specific functions, like soft-air, clean cut seal, etc., are turned either on or off. • If the function is turned on, the value may be adjusted by pressing the  and  buttons. •  Resets the original value. •  Saves changes and returns to the home menu.
	<p>Multi-functional button: performs various functions, depending on the active menu:</p> <p>Home menu :</p> <ul style="list-style-type: none"> • No effect while in the PA program. • For programs P1-9, displays the entered values. <p>Settings menu :</p> <ul style="list-style-type: none"> • For specific functions, like soft-air, clean cut seal etc., the  button is used to turn the function ON/OFF.
<p>P1 – P9</p>	<p>Programs 1 through 9:</p> <ul style="list-style-type: none"> • Each program may be customized by turning certain functions on or off and by adjusting the function values.
<p>PA AUTOMATIC</p>	<p>PA - Automatic:</p> <ul style="list-style-type: none"> • Program with factory settings for vacuum and sealing functions, which is activated when turning on the machine for the first time.
<p>P H₂O</p>	<p>P H₂O – Program:</p> <ul style="list-style-type: none"> • To be used when packing liquids or semi-liquids, like sauces and soups. • Program jumps to the sealing function as soon as product boiling is detected; this prevents product loss through spillage and evaporation.

OPERATION

	<p>When turning off the machine with the  button, the  symbol will start blinking on the LCD display:</p> <ul style="list-style-type: none"> • The pump will stop after about 4 seconds. • Press the  button for a second time and the pump will stop immediately. • Close the lid; the machine will initiate the cool-down phase and perform a number of vacuum cycles before turning off automatically. • These additional cycles allow any moisture in the oil of the pump to evaporate. This increases the longevity of the machine and minimizes the need for oil changes and pump maintenance.
	<p>Service symbol:</p> <ul style="list-style-type: none"> • After reaching a certain number of operating hours or packing cycles, the service symbol will briefly appear on the display when turning on the machine. In addition, the display indicates how many hours or cycles remain before an oil change is required. • Except for regularly changing the oil in the pump, the machine requires little other routine maintenance. • After reaching the service limit, the display will indicate the negative number of exceeded operating hours or cycles. • To reset the service interval counters after the oil change: start machine  and while the display shows the hours or cycles, press and hold the  button to reset.

PROGRAMMING THE MACHINE

ONE-PROGRAM CONTROL SYSTEM



- The one-program control system is standard on the S20, S30, S40, S50, M10, M30 (with 21m³ pump).
- The one-program control system is time-based.
- The ten-program control system (time or sensor) is optional for these models, except for S20.

THE ONE-PROGRAM CONTROL SYSTEM PROVIDES ONLY ONE PROGRAM (P1)

- There is no memory to store additional values.
- The machine starts with the values that were most-recently used.
- The pump starts upon closing of the cover and stops when it is reopened.

PROGRAMMABLE FUNCTIONS

The following function values may be customized for P1:

-  Vacuum time: in seconds.
-  Sealing time: in seconds.



PROGRAMMING

1. Turn the machine on by pressing the on/off button.
 - a. The factory setting for the vacuum time is 30-40 seconds.
 - b. The factory settings for the seal time is 2 seconds.





REVIEWING VACUUM TIME AND SEALING TIME

1. Press the  button to display the programmed vacuum time the vacuum time is pre-set at the factory.





OPERATION

2. Press the  button to display the programmed sealing time the sealing time is pre-set at the factory at 2 seconds. 



ADJUSTING VACUUM TIME FOR P1

1. Press twice on the  or  button.
 - After pressing once, the programmed value is displayed.
 - After pressing twice, the  symbol will start blinking and the value may be adjusted.
2. Save the new value by pressing the menu button.
3. To retain the original value, press the  button.
4. Exit the program by pressing the menu button.

ADJUSTING SEALING TIME FOR P1

1. Press twice on the  or  button.
 - After pressing once, the programmed value is displayed.
 - After pressing twice, the  symbol will start blinking and the value may be adjusted.
2. Save the new value by pressing the menu button.
3. To retain the original value, press the  button.
4. Exit the program by pressing the menu button.

TURNING OFF MACHINE

1. Turn the machine off by pressing the  button.
2. The  symbol on the display will start blinking.
3. Push the  button a second time and the pump will stop immediately.
4. If no action is taken the pump turns off after 4 seconds.
5. Close the cover and the machine will initiate the cool-down phase and perform a number of vacuum cycles while the cover stays closed and the machine will turn off automatically after about 15 minutes.
 - These cycles are necessary to cool down the machine and to allow any moisture in the oil of the pump to evaporate.







TEN-PROGRAM CONTROL SYSTEM

- The ten-program control system is standard time-based on the M20, M40-M80, L01-L60.
 - Sensor-based operation is an option, which can be installed at a later date.
- The ten-program control system provides:
 - 9 customizable programs (P1-P9).
 - Program PA; this is an - automatic program – pre-set at the factory at a vacuum time of 30-40 seconds (or 5 mbar for a sensor-based program) and a sealing time of 2 seconds.
- Program P H2O for liquid products.
 - When turning on the machine, the pump will start. After about 15 minutes of inactivity, the pump will stop automatically.







PROGRAMMABLE FUNCTIONS

The following functions may be customized for each program P1-P9:









OPERATION

-  **Vacuum time:** in seconds or mbar (only with sensor).
-  **Sealing time:** in seconds.
-  **Vacuum plus:** on/off, in seconds.
-  **Gassing:** on/off, in seconds or mbar (only with sensor).
-  **Clean cut controlled (CCC) seal:** on/off, in seconds.
-  **Soft-air:** on/off, in seconds or mbar (only with sensor).
-  **Multi-cycle:** on/off, in number of cycles.

REVIEWING FUNCTION VALUES FOR P1-P9





1. Turn the machine on by pushing the  button.
2. The most-recently used program will be indicated.
3. All selected functions for this program are indicated at the bottom of the display.
4. To review the values for these functions, push the  button; use the  button to display each function value.
5. The values cannot be changed; this can only be done in the settings menu.
6. Push the  button to return to the home menu.

PROGRAMMING AND ADJUSTING VALUES FOR P1-P9









1. Select the program to be set up or adjusted.
2. Push the menu button to access the settings menu.
3. All functions for the selected program are indicated at the bottom of the display.
4. Push the  button to select the blinking function to be adjusted.
5. Adjust the value of the selected function with the 
 button.
6. Press the  button to reset all functions to their original values.
7. Select the next function with the  button.
8. Press the menu button to save the entered values and to return to the home menu.

TURNING PROGRAM FUNCTIONS ON/OFF

The following functions can be turned ON/OFF for each program P1-P9:

-  **Vacuum plus:** on/off, in seconds.
-  **Gassing:** on/off, in seconds or in mbar (only with sensor).
-  **Clean cut controlled (CCC) seal:** on/off, in seconds.
-  **Soft-air:** on/off, in seconds or in mbar (only with sensor).
-  **Multi-cycle:** on/off, in number of cycles.

ADJUSTING ON/OFF FUNCTION VALUES

1. Press the menu button to select the settings menu.
2. Use the  button to select the blinking function to be adjusted.
3. Press the 
 button to select the desired value.
4. Press the  button to reset all functions to their original values.
5. Select the next function with the  button.

OPERATION

6. Push the menu button to store all selected values and to return to the home menu.

TURNING OFF MACHINE

- Follow the same procedure as for the one-program control system.

MAINTENANCE

GENERAL

Regular maintenance prevents equipment malfunctions and prolongs the life of the machine. In addition, it optimizes sanitary conditions.

- Always have a certified Henkovac dealer carry out repair and maintenance activities.

WARNING

- During maintenance activities, always turn the machine off at the main switch and/or unplug it from the electrical outlet.



ATTENTION

Observe the recommended service intervals. Overdue maintenance may lead to costly repairs and overhauls, and may void the equipment warranty.



- After reaching a programmed number of operating hours or packing cycles, the service symbol  will briefly appear on the display when the machine is started up. In addition, the display will indicate how many hours or cycles remain before an oil change is required.
- After passing the service limit, the display will indicate the negative number of excess operating hours or cycles.

VACUUM PUMP

To protect the vacuum pump, proper maintenance is important. Carry out the following tasks carefully:

- Check the vents and clean as necessary before turning on the machine to assure proper cooling of the pump.
- When the air filter is saturated with oil, an oil mist may be expelled; replacement of the filter is required.
- Use the cool-down/dehumidification feature. When turning off the machine  and closing the cover , the pump continues to run for some time. Any moisture in the oil of the pump will evaporate during this phase. This increases the longevity of the machine and minimizes the need for oil changes and pump maintenance.
- Check the oil level regularly and add as needed.
- Change the oil when the service symbol  appears on the display.

NOTE

To reset the service interval counters after the oil change: start machine  and while the display shows the hours or cycles, press and hold the  button.

MAINTENANCE

ADDING AND CHANGING THE PUMP OIL

WARNING

The operating temperature of the pump is 70°C / 158°F or higher. Wear gloves when servicing the pump or let it cool off sufficiently to prevent injuries.

ADDING OIL

1. Remove the oil filler cap.
2. Add oil up to the maximum-level mark; use oil according to DIN 51506, lubrication oil group VC. When in doubt, consult your dealer.
3. Replace the oil filler cap.
4. After several packing cycles, check the oil level and add as needed.

CHANGING OIL

1. Remove the oil drain plug and drain the oil.
2. Replace the drain plug.
3. Remove the oil filler cap.
4. Add the correct oil up to the maximum-level mark.
5. Replace the oil filler cap.
6. To reset the service interval counters after the oil change: Start machine and while the display shows the hours or cycles, press and hold the  button.

NOTE

Collect the oil to have it processed and recycled according to the locally applicable regulations.

Note: hydraulic oil to be used is Omcan item 15713.

SEAL BEAMS AND COUNTER BEAMS

To achieve a quality seal, it is necessary that the seal beam and counter beam are in good condition.

1. Clean the seal and counter beams daily with a dry cloth.
2. Replace the Teflon tape on the seal beam if damaged and replace the sealing wire if kinked.
3. Replace the silicone rubber seal if it is burned in.

Depending on the type of machine, there are three seal beam versions:

1. Single-seal beam (T2).
2. Stainless steel seal beam.
3. Aluminum seal beam.

SINGLE-SEAL BEAM

REMOVE THE SEALING WIRE AND TEFLON TAPE AS FOLLOWS:

1. Grab the seal beam in the middle and pull it straight up and out of the machine.
2. The beam is held in place by 2 pins; some force may be necessary to loosen the beam.

MAINTENANCE

3. Remove the brown Teflon tape that is applied to the seal beam.
4. Remove the two screws on the underside of the seal beam; this releases the sealing wire.
5. Clean the seal beam thoroughly and remove any glue residue off the Teflon tape.

NOTES

- Check the condition of the tensioning springs at both ends of the seal beam; replace if necessary.
- These springs maintain tension on the sealing wire.
- Using the seal beam without the springs may cause sealing wires to break.

INSTALL THE SEALING WIRE AND TEFLON TAPE AS FOLLOWS:

1. Position the sealing wire across the beam and fasten it on one side with a small bolt.
2. Apply tension on the wire by pulling it with a pair of pliers.
3. Fasten the wire on the opposite end of the beam with the second bolt and cut the wire to length; the ends of the sealing wire must be long enough to make electrical contact with the pins in the vacuum chamber.
4. Apply the Teflon tape smooth and tight over the seal beam; make sure that the beam is clean and free of grease.
5. Re-install the beam in the vacuum chamber; check to make sure that the ends of the sealing wire make contact with the steel pins.

ALUMINUM/STAINLESS STEEL SEAL BEAM

REMOVE THE SEALING AND CUTTING WIRES AS FOLLOWS:

1. Remove the old wires by pulling them loose from the seal beam contacts.
2. Loosen the clamp screws and remove the seal beam from the U-profile.
3. Remove the Teflon tape from the seal beam.
4. Remove the mounting plates on both ends of the seal beam by loosening the screws; this releases the sealing wires and/or sealing and cutting wires.
5. Clean the seal beam thoroughly.

NOTES

- After removal of the wires, check the strips of fiber glass for damage; replace if necessary.
- Check the condition of the tensioning springs at both ends of the seal beam; replace if necessary.
- Using the seal beam without the springs may cause the sealing wires to break.
- Check contact plate for damage; replace if necessary.

INSTALL THE SEALING AND CUTTING WIRES AS FOLLOWS:

1. If necessary, install new strips of fiber glass on the seal beam.
2. Insert the new wires behind one of the mounting plates and tighten the screws; make sure that the end of the wires line up with the bottom edge of the mounting plate.
3. Position the wires across the seal beam and loosely install the second mounting plate.
4. Carefully clamp the seal beam upside down in a bench vice.
5. Pull the wires as tightly as possible with a pair of pliers and secure the second mounting plate by tightening the screws.

MAINTENANCE

NOTE

1. The wires can be further tightened by slightly loosening the screws of one of the mounting plates.
2. Pull the wires one-by-one tighter with a pair of pliers.
3. Re-tighten the screws after the correct tension has been achieved.
4. Cut the end of the wires flush with the bottom edge of the mounting plate.
5. Apply the Teflon tape smooth and tight over the seal beam without creases. Make sure that the beam is clean and free of grease.
6. Re-install the seal beam in the vacuum chamber and re-connect the wires.

ALUMINUM T-SHAPED SEAL BEAM

REMOVE THE SEALING WIRES AS FOLLOWS:

1. Remove the seal beam from the machine.
2. Remove the Teflon tape.
3. Loosen the screws on both sides of the beam; this will release the sealing wires.
4. Clean the seal beam thoroughly.

INSTALL THE SEALING WIRES AS FOLLOWS:

1. Apply new fiber glass to the beam if necessary.
2. Place new wires on the beam and fasten them on one side with mounting plates; tighten the screws.
3. Position the wires across the beam.
4. Fasten mounting plates; tighten screws.
5. Carefully clamp the beam in a bench vice.
6. Pull the wires as tightly as possible with a pair of pliers.
7. Secure the mounting plates with the screws.

NOTES

- Check the strip of fiber glass for damage and replace if necessary.
- Check the springs and replace if necessary.
- Using the seal beam without the springs may cause the sealing wires to break.

APPLYING TEFLON TAPE TO SEAL BEAM

1. Position the new Teflon tape on the seal beam and cut out the corners.
2. Remove the protective backing from the Teflon tape.
3. Apply the new tape to the seal beam; the tape has an adhesive strip on both sides.
4. Slide the seal beam onto the pins in the vacuum chamber (machines with transparent cover).
5. Slide the seal beam in the holder of the cover, tighten the mounting screws, and re-connect the wires (machines with metal cover).

NOTE

- The Teflon tape must not adhere to the tension blocks.

REPLACING SILICONE RUBBER SEAL OF COUNTER BEAM

The rubber seal is clamped in the counter beam. Replace the counter beam seal as follows:

MAINTENANCE

1. Pull the old rubber seal from the groove in the counter beam.
2. Clean the groove.
3. Evenly press the new rubber seal into the groove and make sure that it does not stick out at either end of the counter beam.

RUBBER SEAL OF VACUUM CHAMBER COVER

To assure that the vacuum chamber is properly sealed, it is important that the rubber seal is in good condition and is not damaged. Replace the cover seal as follows:

1. Copy the length of the original rubber seal.
2. Pull the original rubber seal from the groove.
3. Clean the groove.
4. Evenly press the rubber seal into the groove; position the ends of the seal tightly against each other to prevent leakage.

STRUTS, DAMPERS AND SPRINGS

- Machines with transparent covers are equipped with gas struts to open the cover.
- Machines with metal covers are equipped with oil dampers and springs to open the cover.
- Have the struts, dampers and springs checked by your dealer once every 5 years and have them replaced as necessary.
- Have the gas struts replaced if the lid no longer opens properly.

VACUUM HOSES AND TUBES

- Check the vacuum hoses and tubes for kinks, tears and porosity; replace if necessary.

TROUBLESHOOTING

Fault/Symptom	Possible Cause	Remedy
Machine does not work.	The machine is not plugged in.	Plug the machine into the electrical outlet.
	The ground fault safety in the electrical panel has tripped.	Check the electrical panel.
	A fuse in the electrical panel is faulty.	Check the electrical panel.
	A fuse in the machine is faulty.	Consult your dealer.
	The motor protection of the machine is switched off.	Consult your dealer.

TROUBLESHOOTING

The vacuum pump does not run at full speed.	The oil is too thick or contaminated.	Change the oil.
	The pump motor runs on two phases.	Check the voltage; if correct, consult your dealer.
The vacuum in the package is insufficient.	The programmed vacuum value is too high.	Lower the vacuum value in the program.
	The packaging material is of poor quality.	Select a better-quality packaging material.
	The product damages the bag.	Program a higher value for soft-air.
	The machine gases the package.	Turn off the gassing function.
The seal is leaking.	The package seam is poorly formed.	Increase the sealing time and/or reduce the MAP gas pressure.
	The package seam is burnt.	Decrease the sealing time.
	The opening of the vacuum bag is contaminated.	Try again and make sure that the opening of the bag stays clean.
	The sealing beam is dirty.	Clean the sealing beam.
	The Teflon lining of the sealing beam is damaged.	Replace the Teflon lining.
	The silicon rubber seal in the counter beam is damaged.	Replace the silicon rubber seal.
There is not enough gas in the bag.	The bag is too small.	Select a bigger bag.
	The programmed gas level is too low.	Increase the gas level value.
	The bag is not correctly positioned over the gas outlets.	Adjust the bag position.
The machine does not seal.	The bag is not correctly positioned over the sealing beam.	Adjust the bag position.
	The sealing wire is broken.	Replace the sealing wire.
	The thermal safety of the power supply was tripped.	Wait until the safety resets, which can take half an hour. Decrease the sealing time.
	The electrical contacts of the seal beam have fouled.	Remove the seal beam and clean the pins and contacts with sand paper.

TROUBLESHOOTING

<p>The service symbol appears when turning on the machine, indicating the remaining production hours or cycles.</p>	<p>The service interval counters have reached their maximum programmed values.</p>	<p>To reset the service interval counters after the oil change: start the machine and while the display shows the hours or cycles, press and hold the "X" button.</p>
---	--	---

PARTS BREAKDOWN

ITEM	MODEL
59006	VP-NL-0004-SN
59007	VP-NL-0008-SN

Overall

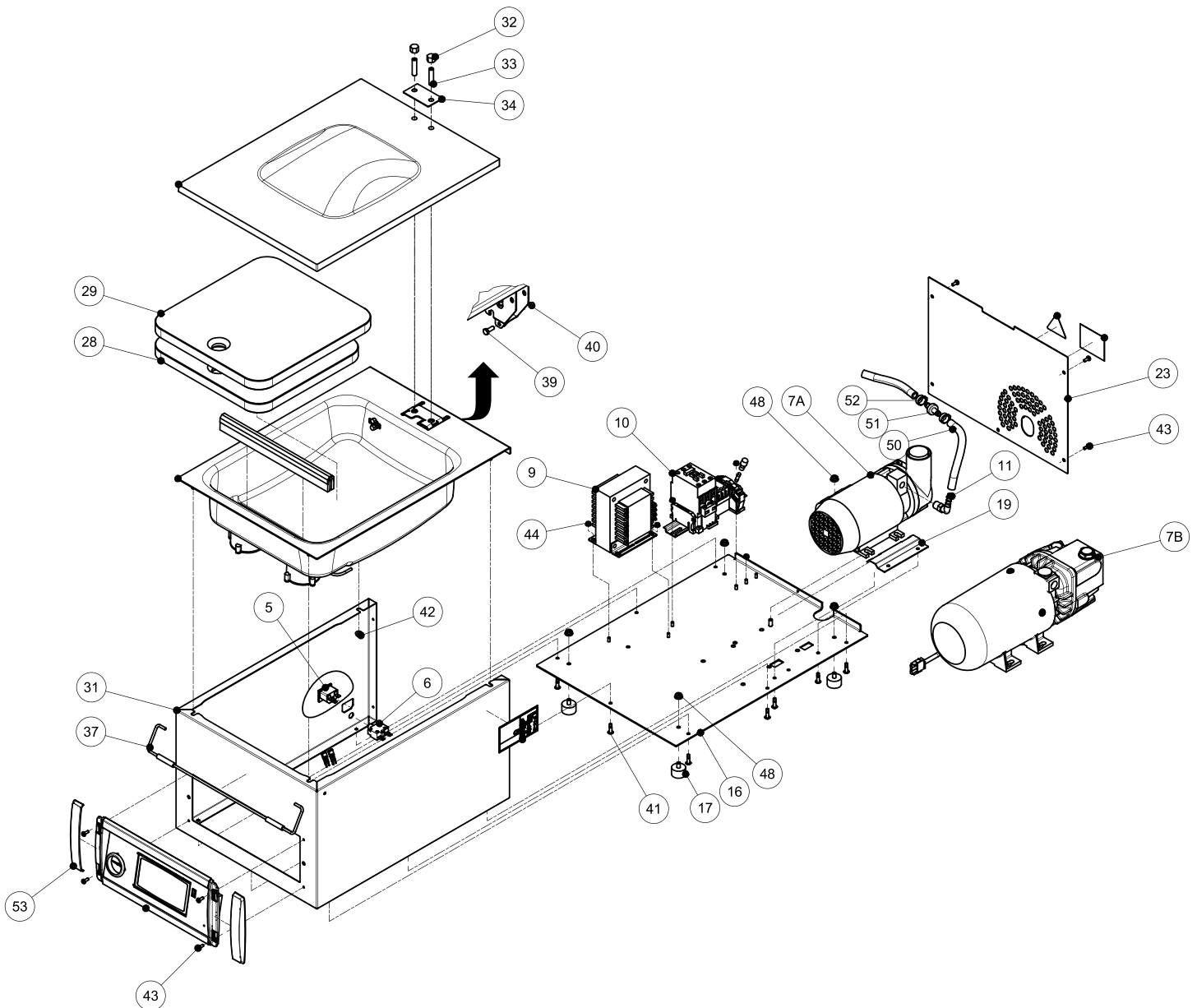

PARTS BREAKDOWN

ITEM	MODEL
59006	VP-NL-0004-SN
59007	VP-NL-0008-SN

Vacuum Chamber

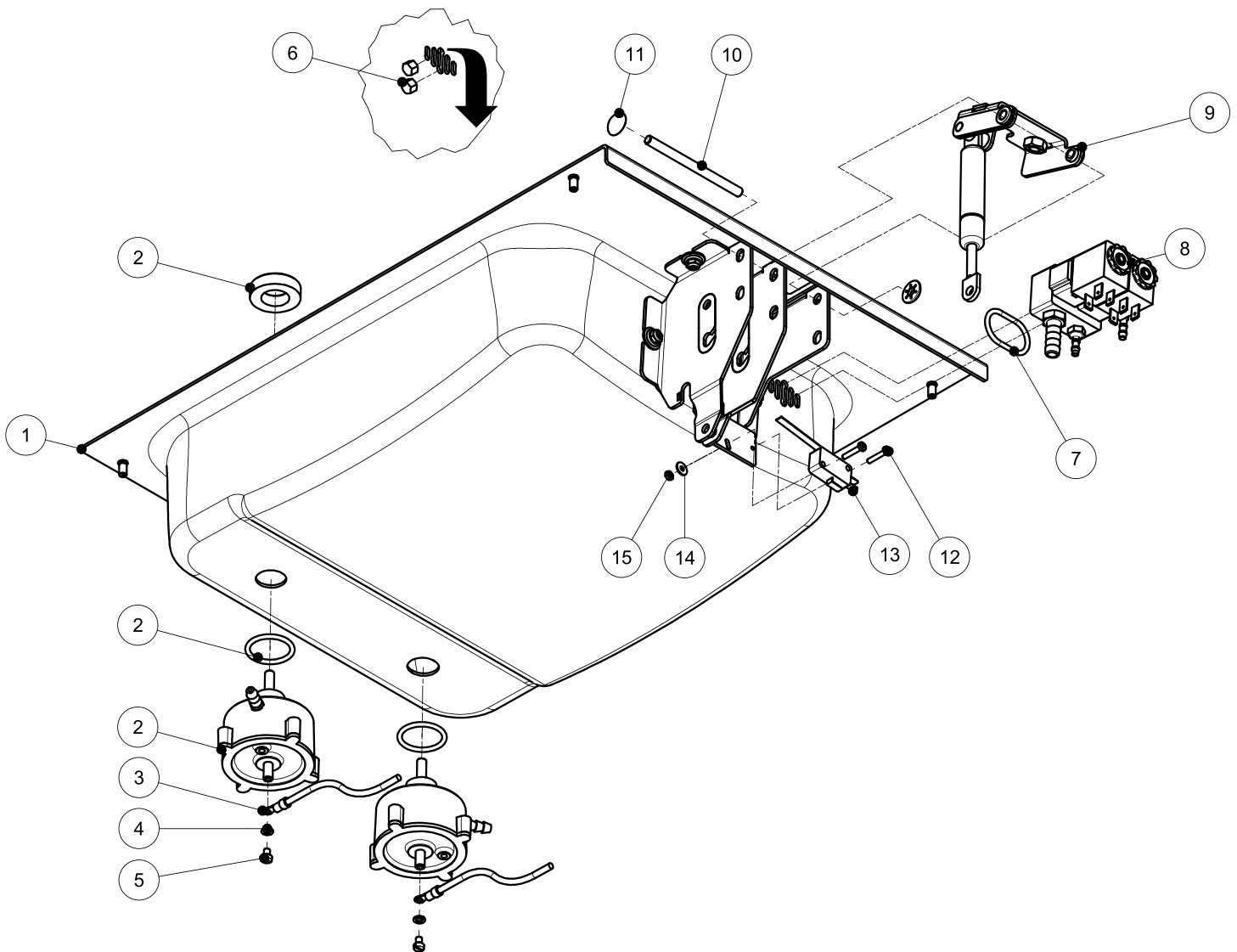

PARTS BREAKDOWN

ITEM	MODEL
59006	VP-NL-0004-SN
59007	VP-NL-0008-SN

Lid

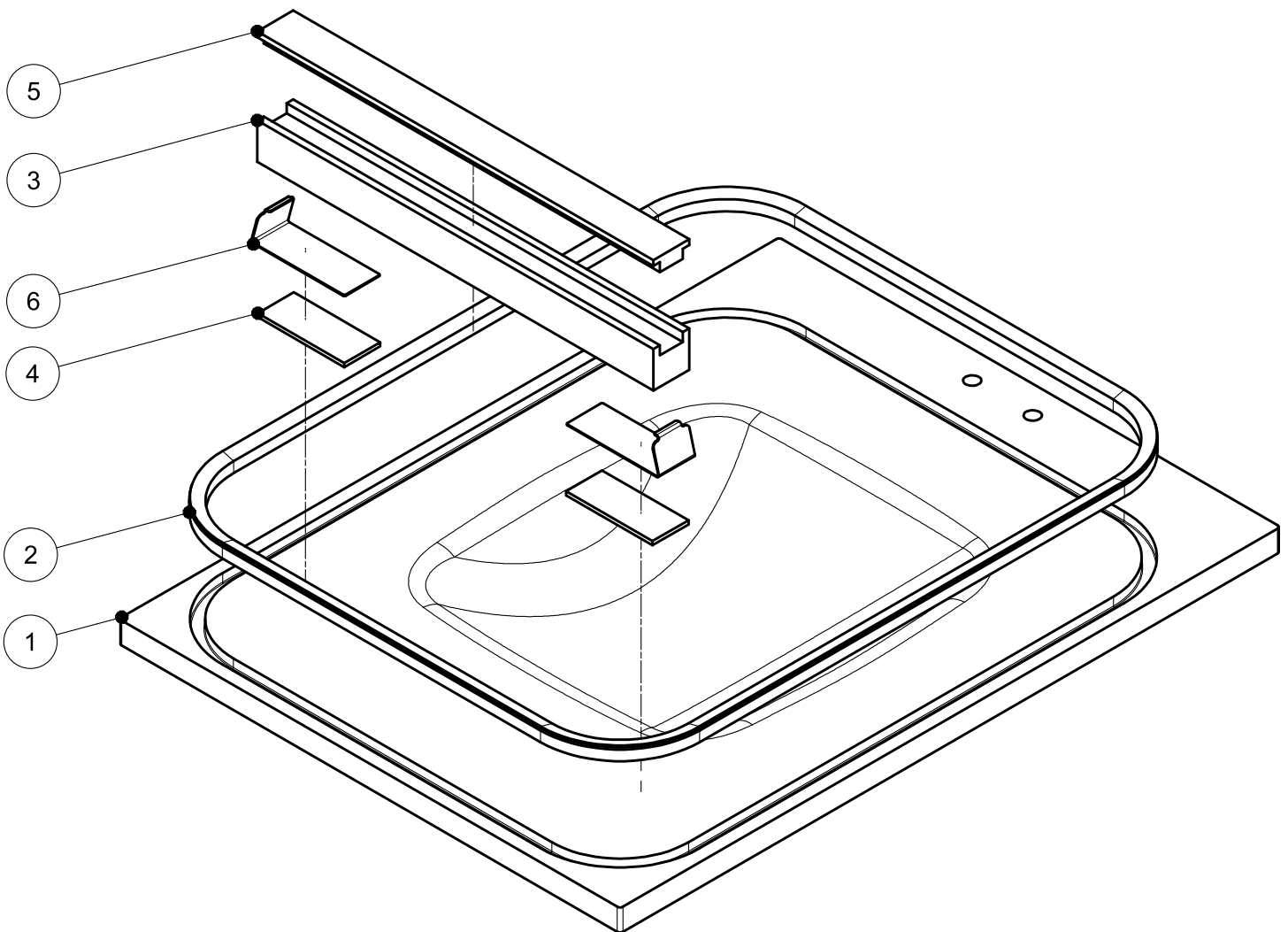

PARTS BREAKDOWN

ITEM	MODEL
59006	VP-NL-0004-SN
59007	VP-NL-0008-SN

Hinge

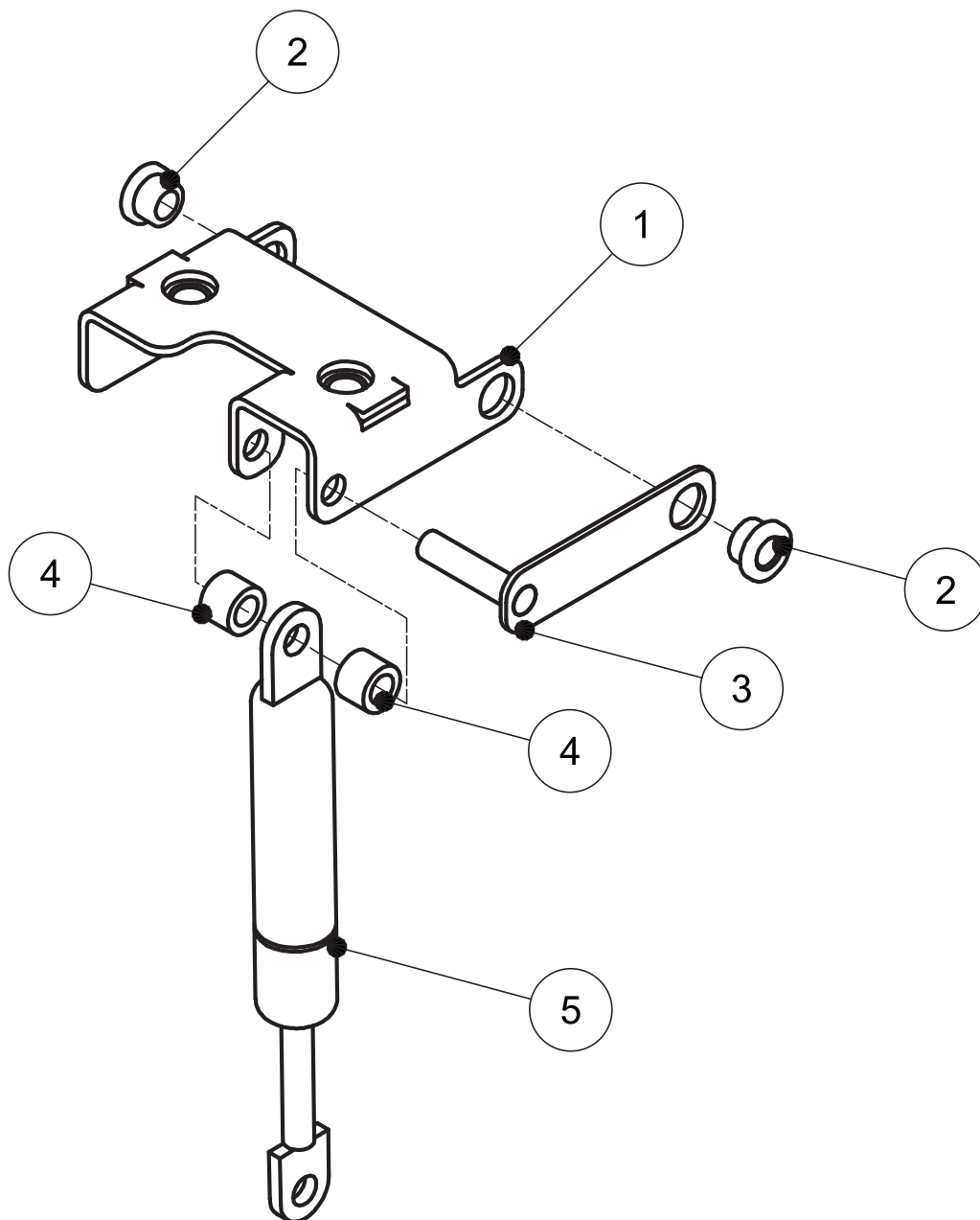

PARTS BREAKDOWN

ITEM	MODEL
59006	VP-NL-0004-SN
59007	VP-NL-0008-SN

Air Valve

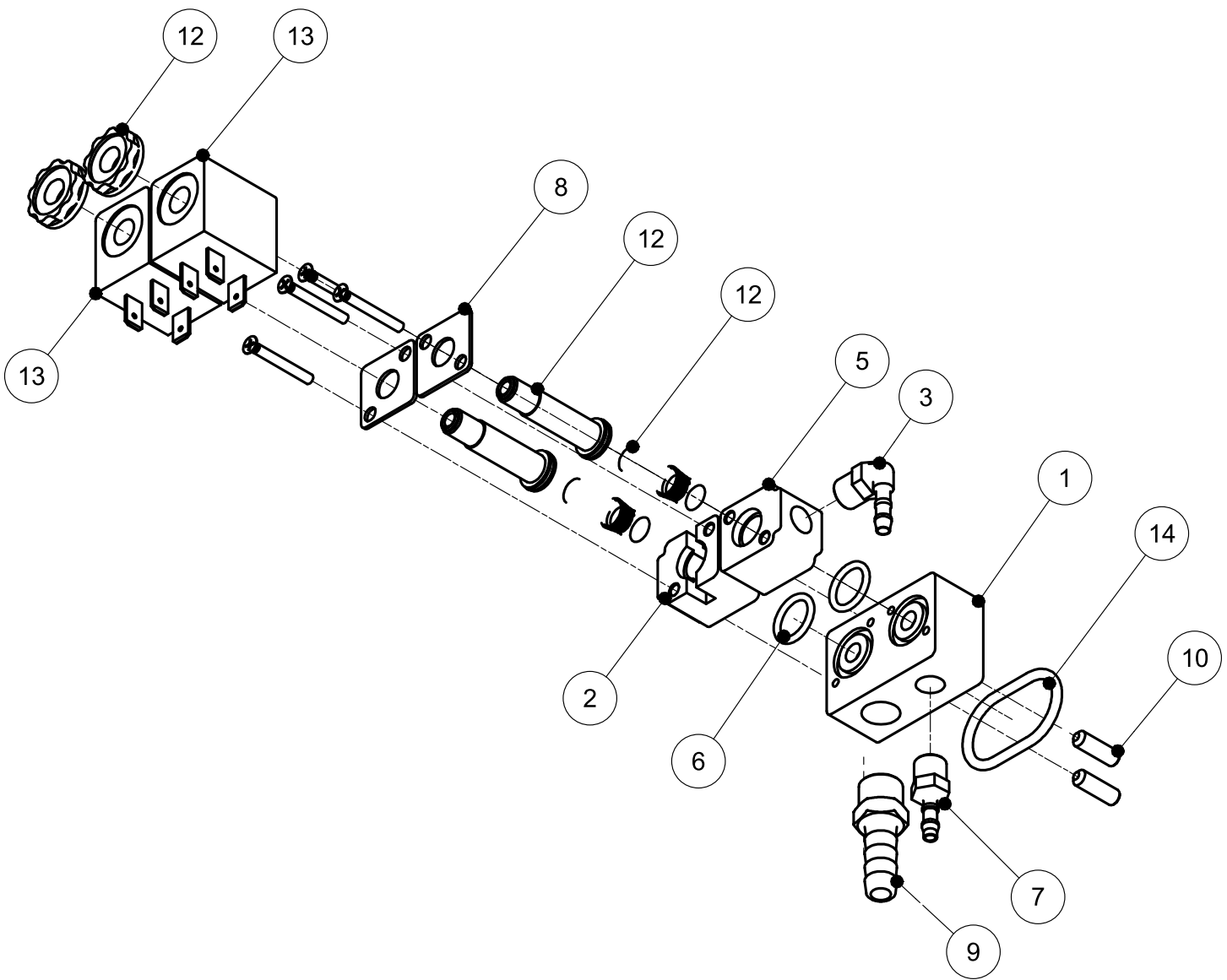

PARTS BREAKDOWN

ITEM	MODEL
59006	VP-NL-0004-SN
59007	VP-NL-0008-SN

Sealbeam

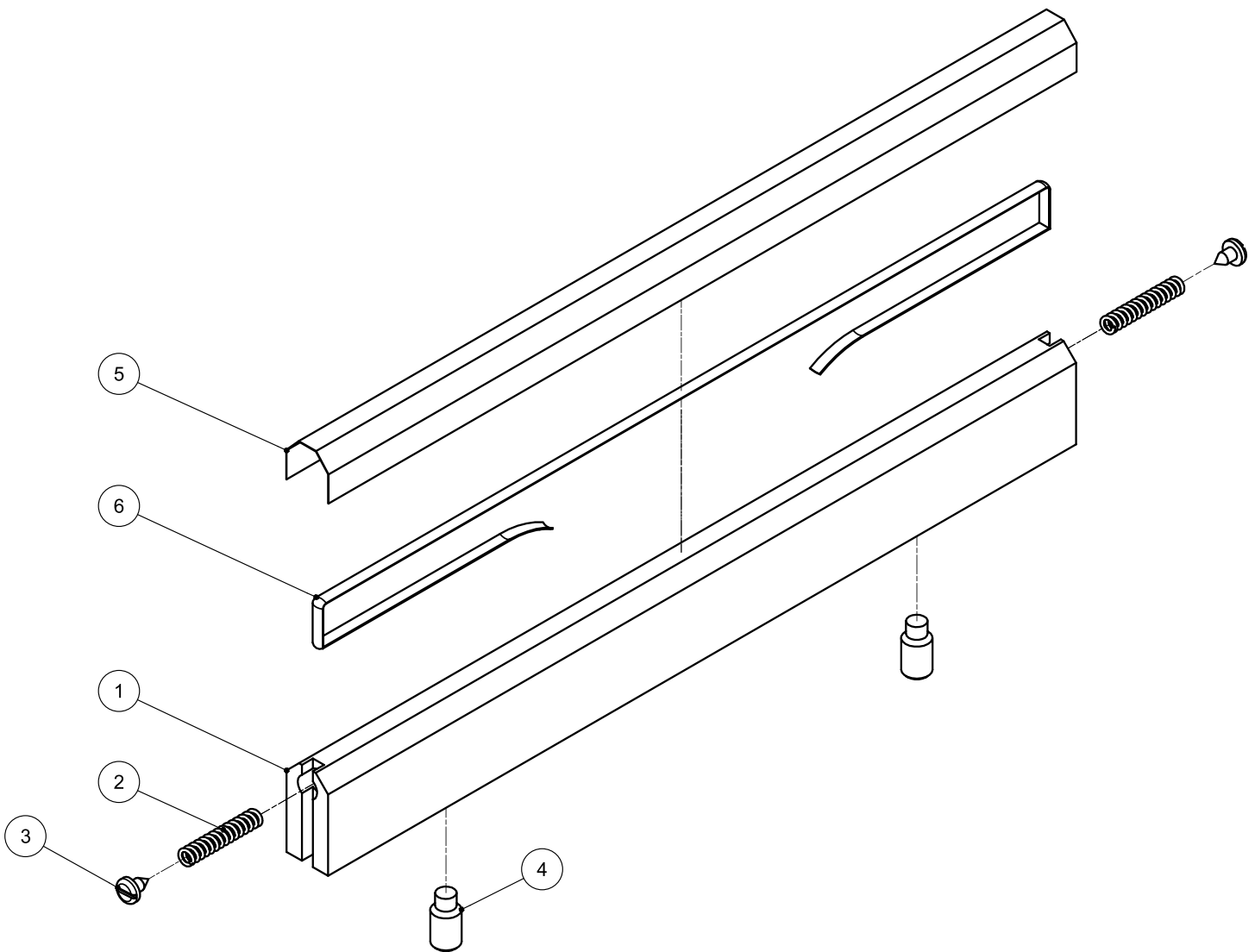

PARTS BREAKDOWN

ITEM	MODEL
59006	VP-NL-0004-SN
59007	VP-NL-0008-SN

4m³ Transformer

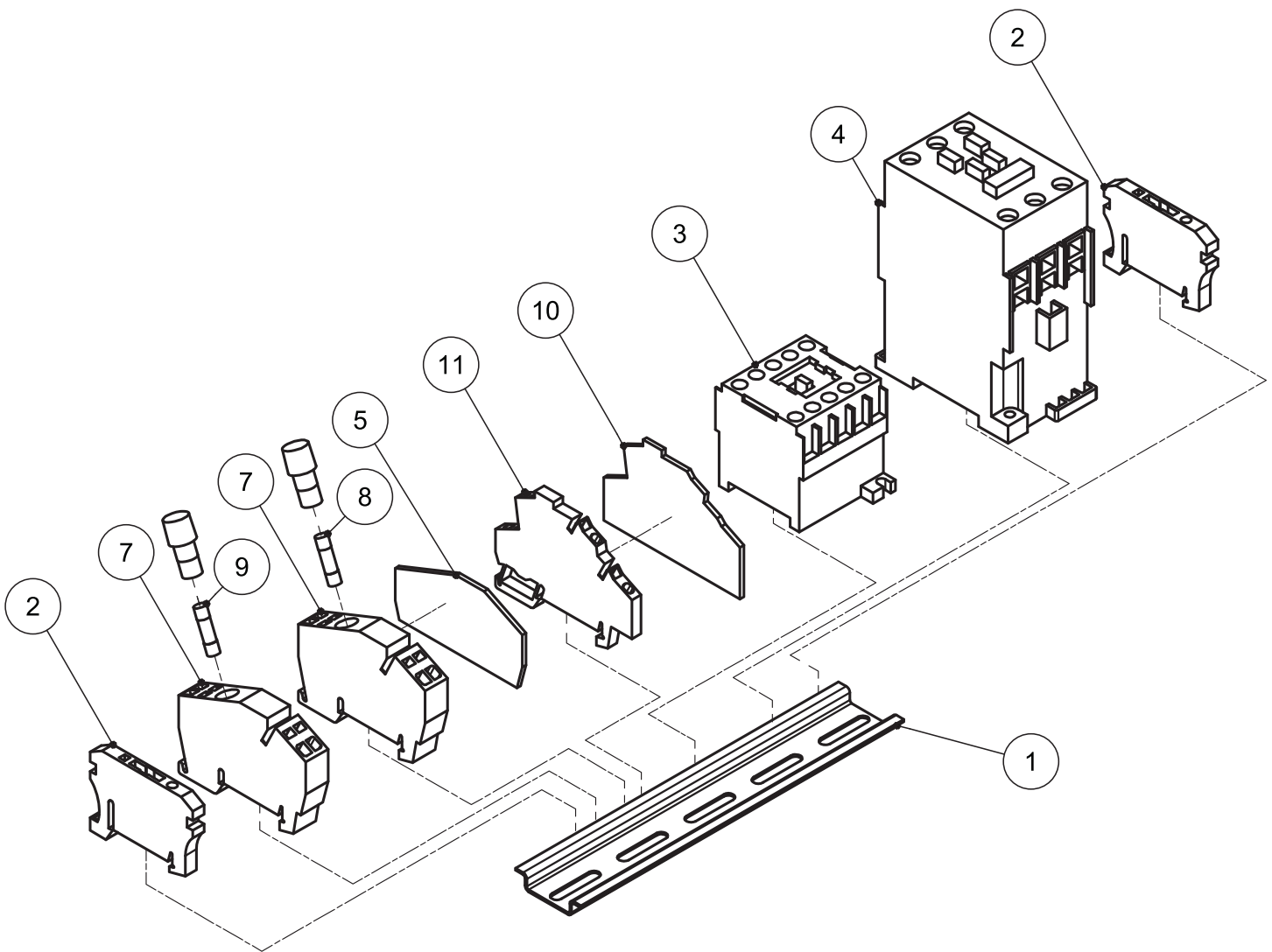

PARTS BREAKDOWN

ITEM	MODEL
59006	VP-NL-0004-SN
59007	VP-NL-0008-SN

8m³ Transformer

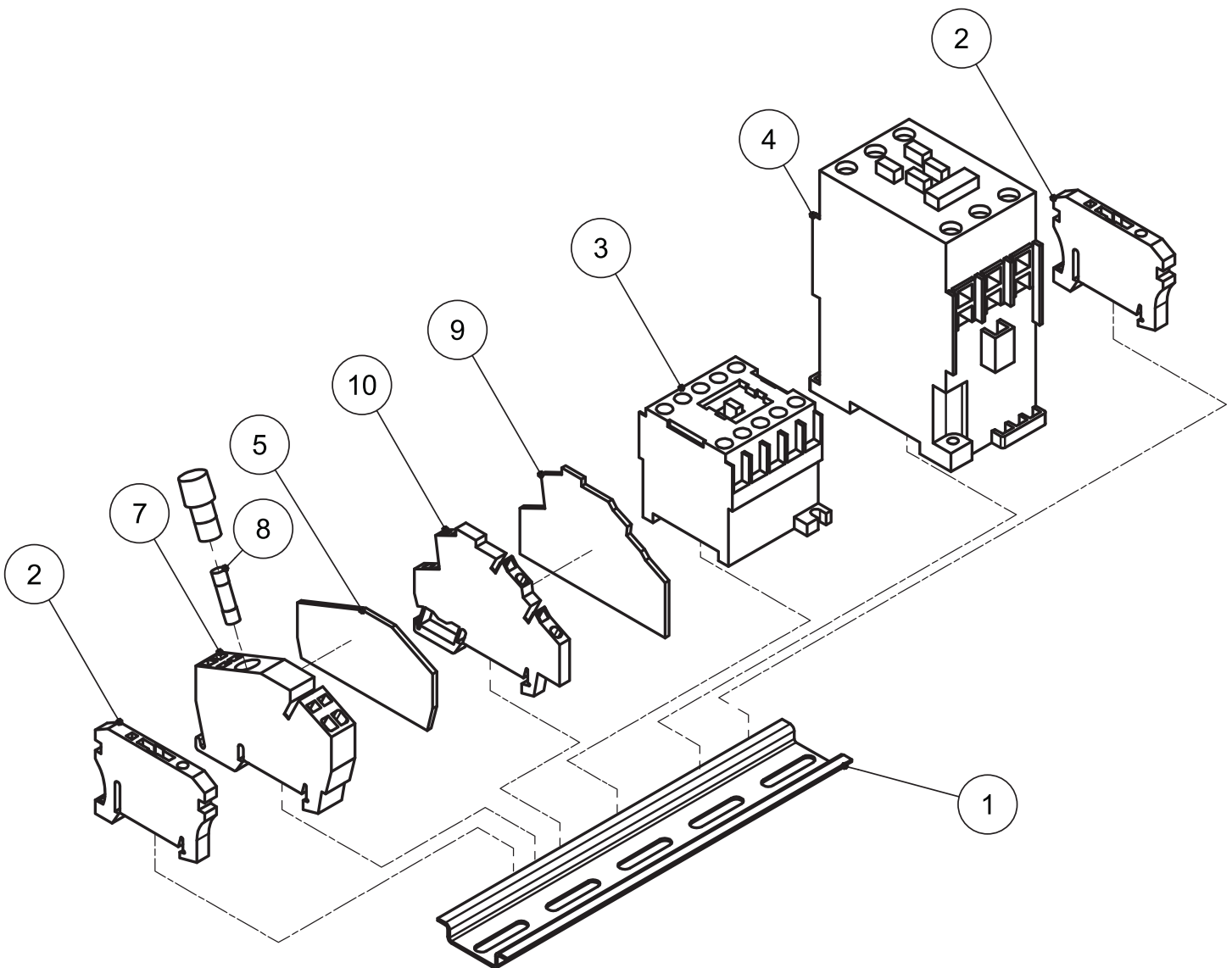

PARTS BREAKDOWN

ITEM	MODEL
59006	VP-NL-0004-SN
59007	VP-NL-0008-SN

Control Panel

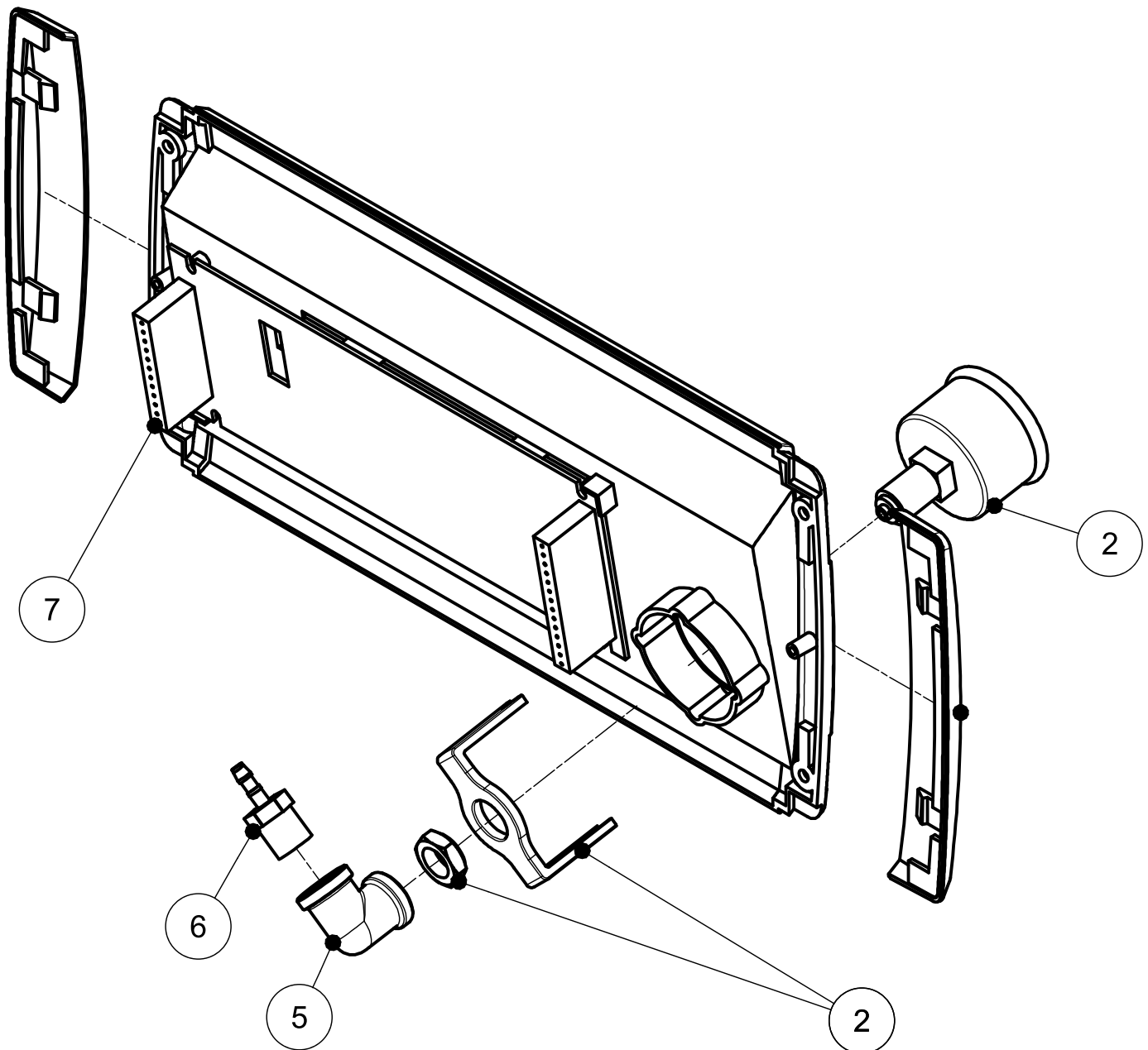

PARTS BREAKDOWN

ITEM	MODEL
59006	VP-NL-0004-SN
59007	VP-NL-0008-SN

Overall

Item No.	Description	Position	Item No.	Description	Position	Item No.	Description	Position
15884	Sealbeam Standard Compact Complete for 59006, 59007	4	AI831	Clamping Plate Pump T1 T2-4m3 for 59006, 59007	19	65749	M6 Hex Nut Din 985 for 59006, 59007	40
27791	Net Entree Male Snap-In STF42 for 59006, 59007	5	AI832	Square Hose Coupling 3 8"x8 Ext. for 59006, 59007	22	65836	Hucknagel Magna-Lok MGLP-B6-4 for 59006, 59007	41
30022	Thermal Fuse 8A for 59006, 59007	6	AI833	Cover Back Side T2 for 59006, 59007	23	27782	Hexagon Flangenut M5 Din 6923 A2 for 59006, 59007	42
30014	Vacuum Pump 004-316 220/240-1-50/60 for 59006, 59007	7A	AI834	Filler Plate Bottom T2 - R2 for 59006, 59007	28	27789	Slott. Rais. Counter. Head Screw M4x10 Din7985 A2 for 59006, 59007	43
AI827	Vacuum Pump 008 220 240-1-50 60 for 59006, 59007	7B	AI835	Filler Plate Top T2 - R2 for 59006, 59007	29	35041	Hose Clip Klemfa 12.8x14.8mm for 59006, 59007	44
15791	Combi-Trafo P100/230V-S16/24V for 59006, 59007	9	AI836	Chassis T2 for 59006, 59007	31	27781	Hexagon Flangenut M6 Din6923 A2 for 59006, 59007	48
AI828	Din Rail B 1 Fase for 59006, 59007	10A	AI837	M8 Hexagon Cap Nut DIN 917 for 59006, 59007	32	AI841	Suction Hose T2 for 59006, 59007	49
AI829	Din Rail A 1 Fase for 59006, 59007	10B	AI838	M8x35 Hexagon Socket Set Screw Din 916 for 59006, 59007	33	63991	Non-Return Valve 8mm for 59006, 59007	51
35476	Square Hose Coupling 1/4x8 Ext. for 59006, 59007	11	AI839	Locking Plate Hinge for 59006, 59007	34	30019	Hose Clip Klemfa 12.8x14.8mm for 59006, 59007	52
AI830	Baseplate T2 for 59006, 59007	16	AI840	Lid Locker T2 for 59006, 59007	37	AI842	Cap Holder 04-Control Mini for 59006, 59007	53
65834	Vibration Absorber D=25 H=17 M6x10 for 59006, 59007	17	27787	Hexagon Screw M6x16 DIN933 A2 for 59006, 59007	39			

Vacuum Chamber

Item No.	Description	Position	Item No.	Description	Position	Item No.	Description	Position
AI843	Vacuum Chamber T2-R2 for 59006, 59007	1	AI846	M5 Hexagon Cap Nut Din 917 for 59006, 59007	6	27810	Spring Ring with Cover 6mm / Shaft Locker with Cover for 59006, 59007	11
AI844	Seal Cylinder for 59006, 59007	2	35852	O-Ring 28x3 for 59006, 59007	7	AI850	M3x16 Cross Recessed Raised Cheese Head Screws - Din 7985 for 59006, 59007	12
AI845	Seal Wire C1 for 59006, 59007	3	AI847	Comb. Valve Model-II for 59006, 59007	8	15775	Micro Switch MV3003L for 59006, 59007	13
65776	Spring Washer Din 127 - A4 for 59006, 59007	4	AI848	Hinge T2 Assembled for 59006, 59007	9	65772	M3 Washer DIN 9021 for 59006, 59007	14
27830	Slotted Cheese Head Screw M4x6 A2 Din84 for 59006, 59007	5	AI849	Pivot T2 for 59006, 59007	10	27823	Hexagon Nut M3 Din934 A2 for 59006, 59007	15

PARTS BREAKDOWN

ITEM	MODEL
59006	VP-NL-0004-SN
59007	VP-NL-0008-SN

Lid

Item No.	Description	Position	Item No.	Description	Position	Item No.	Description	Position
AH261	T2 Vacuum Cover Dome for 59006, 59007	1	AI851	Silicon Bar T2 for 59006, 59007	3	15842	Silicone T-Profile 40 Shore One Meter for 59006, 59007	5
35105	Sil.Profile Lidgasket 8mm 60 SH/25mtr for 59006, 59007	2	62750	Acrytape Dubbelzijdig 25mm L60mm for 59006, 59007	4	65761	Clamping Spring Silicone Holder for 59006, 59007	6

Hinge

Item No.	Description	Position	Item No.	Description	Position	Item No.	Description	Position
AI852	Hinge T2 for 59006, 59007	1	AI853	Locking Plate Hinge Part for 59006, 59007	3	AI855	Gas Spring 0814MF 350N for 59006, 59007	5
35093	Guide Bearing 6x9x6 for 59006, 59007	2	AI854	Spacer 6.2x10x7.5 for 59006, 59007	4	27814	Hexagon Nut M8 Din934 A2 for 59006, 59007	7

Air Valve

Item No.	Description	Position	Item No.	Description	Position	Item No.	Description	Position
AI856	Base Block Combination Valve Model II for 59006, 59007	1	AI859	O-Ring 12x2mm for 59006, 59007	6	27816	Adj.Screw/Soc.Head M5x16 Din916 A2 for 59006, 59007	10
AI857	Adapter Valve 6mm for 59006, 59007	2	AI860	Right Hose Coupling 1.8"x4 Ext. for 59006, 59007	7	AI666	3-2 Armature Met 8mm Seal for 59006, 59007	12
35402	Square Hose Coupling 1/8x4 Ext. for 59006, 59007	3	AI861	Clamping Plate Valve Armature for 59006, 59007	8	AH174	Coil 24Vac 50/60HZ 8.5VA for 59006, 59007	13
AI858	Adapter Valve 2.5mm for 59006, 59007	5	35261	Brass Hose Coupling 1/4x8 Ext. for 59006, 59007	9	35852	O-Ring 28x3 for 59006, 59007	14

Sealbeam

Item No.	Description	Position	Item No.	Description	Position	Item No.	Description	Position
AI862	Sealbeam Compact Mini Maxi for 59006, 59007	1	AI864	Slotted Cheese Head Screw for 59006, 59007	3	AI866	Teflon Tape EN 40mm for 59006, 59007	5
AI863	Compression Spring Seal Beam for 59006, 59007	2	AI865	Adj.Screw Soc.Head M8x16 D915 for 59006, 59007	4	AI867	Seal Wire 3.5x0.3mm L=1mtr for 59006, 59007	6

PARTS BREAKDOWN

ITEM	MODEL
59006	VP-NL-0004-SN
59007	VP-NL-0008-SN

4m³ Tranformer

Item No.	Description	Position	Item No.	Description	Position	Item No.	Description	Position
AC744	Rail JMV35SL 7 Hole 173mm for 59006, 59007	1	65708	Locking Plate Zap ZDU 6-2 for 59006, 59007	5	35323	End Plate Wire Connector for 59006, 59007	10
35305	End Fent for 59006, 59007	2	35306	Fuse Clamp 2.5-2/ZSI for 59006, 59007	7	35315	Double Clamp 2.5-2 for 59006, 59007	11
AI868	Mas AB100-K09KJ400 MS4P 24V 50/60Hz for 59006, 59007	3	15818	Fuse 5x20 4A Slow for 59006, 59007	8			
15772	Contactora 24VAC for 59006, 59007	4	35307	Fuse Keram.5x20 2.5A Delay for 59006, 59007	9			

8m³ Tranformer

Item No.	Description	Position	Item No.	Description	Position	Item No.	Description	Position
AC744	Rail JMV35SL 7 Hole 173mm for 59006, 59007	1	15772	Contactora 24Vac for 59006, 59007	4	35307	Fuse Keram.5x20 2.5A Delay for 59006, 59007	8
35305	End Fent for 59006, 59007	2	65708	Locking Plate Zap ZDU 6-2 for 59006, 59007	5	35323	End Plate Wire Connector for 59006, 59007	9
AI868	Mas AB100-K09KJ400 MS4P 24V 50/60Hz for 59006, 59007	3	35306	Fuse Clamp 2.5-2/ZSI for 59006, 59007	7	35315	Double Clamp 2.5-2 for 59006, 59007	10

Control Panel

Item No.	Description	Position	Item No.	Description	Position
AI879	Control Panel Small-PCB 1-Program for 59006, 59007	1	35413	Elbow 1/4 Int Brass for 59006, 59007	5
35579	Vacuum Meter 40mm for 59006, 59007	2	35414	Hose Pillar 1/4x4 BU R Norma for 59006, 59007	6

PARTS BREAKDOWN

ITEM	MODEL
59008	VP-NL-0016-SN
59009	VP-NL-0021-SN
59010	VP-NL-0016-LN

Overall

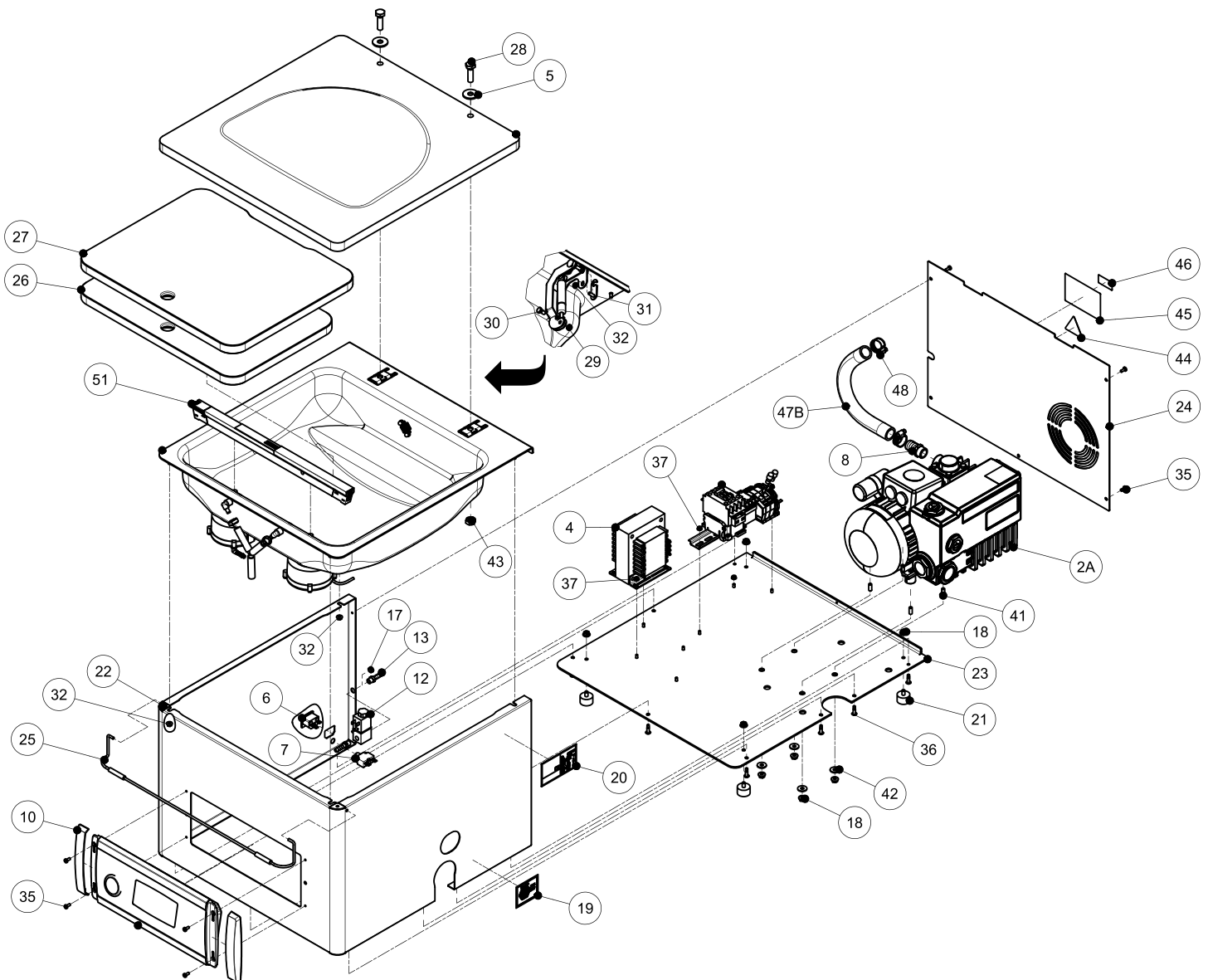

PARTS BREAKDOWN

ITEM	MODEL
59008	VP-NL-0016-SN
59009	VP-NL-0021-SN
59010	VP-NL-0016-LN

Vacuum Chamber

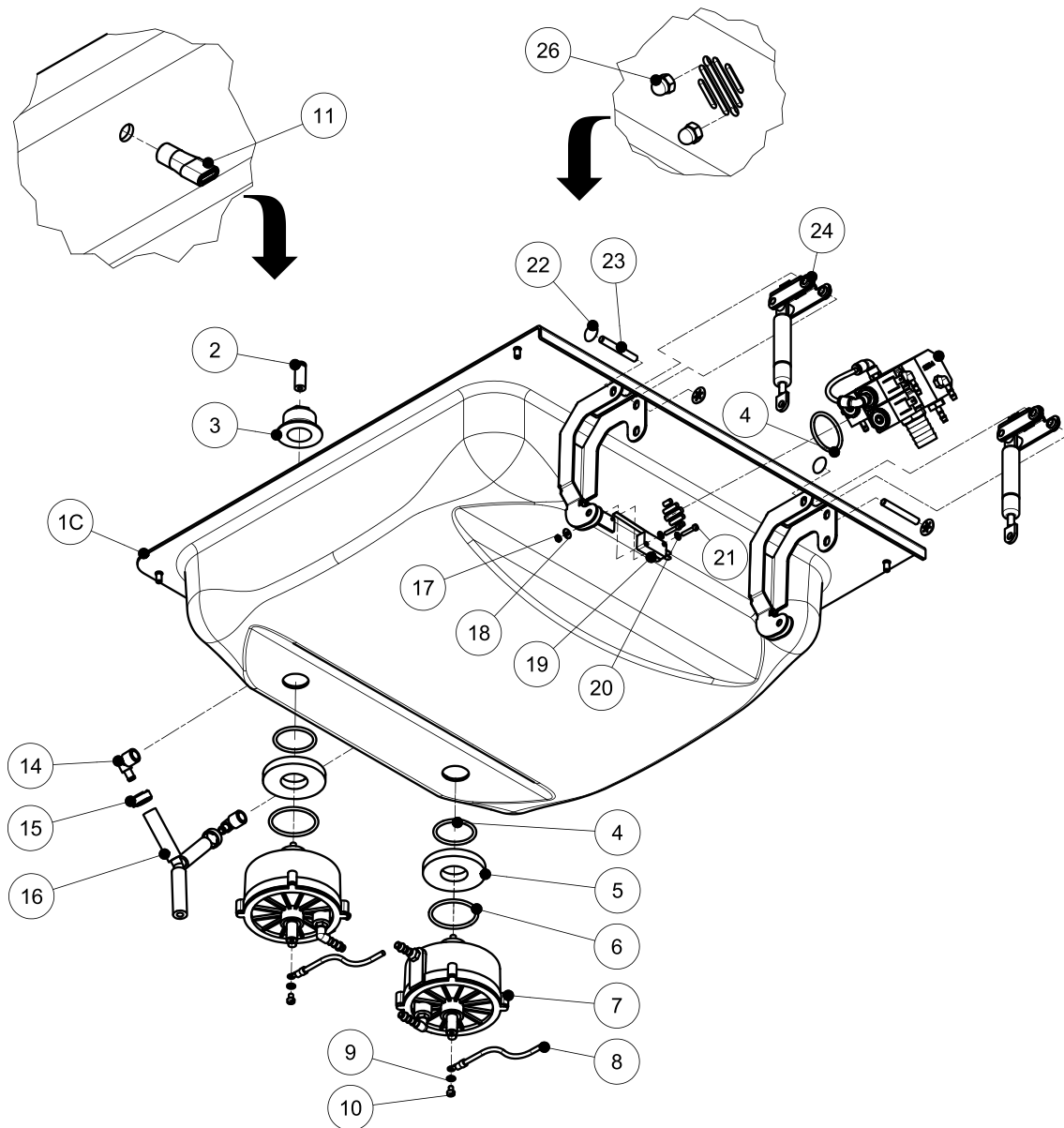

PARTS BREAKDOWN

ITEM	MODEL
59008	VP-NL-0016-SN
59009	VP-NL-0021-SN
59010	VP-NL-0016-LN

Seal Lid

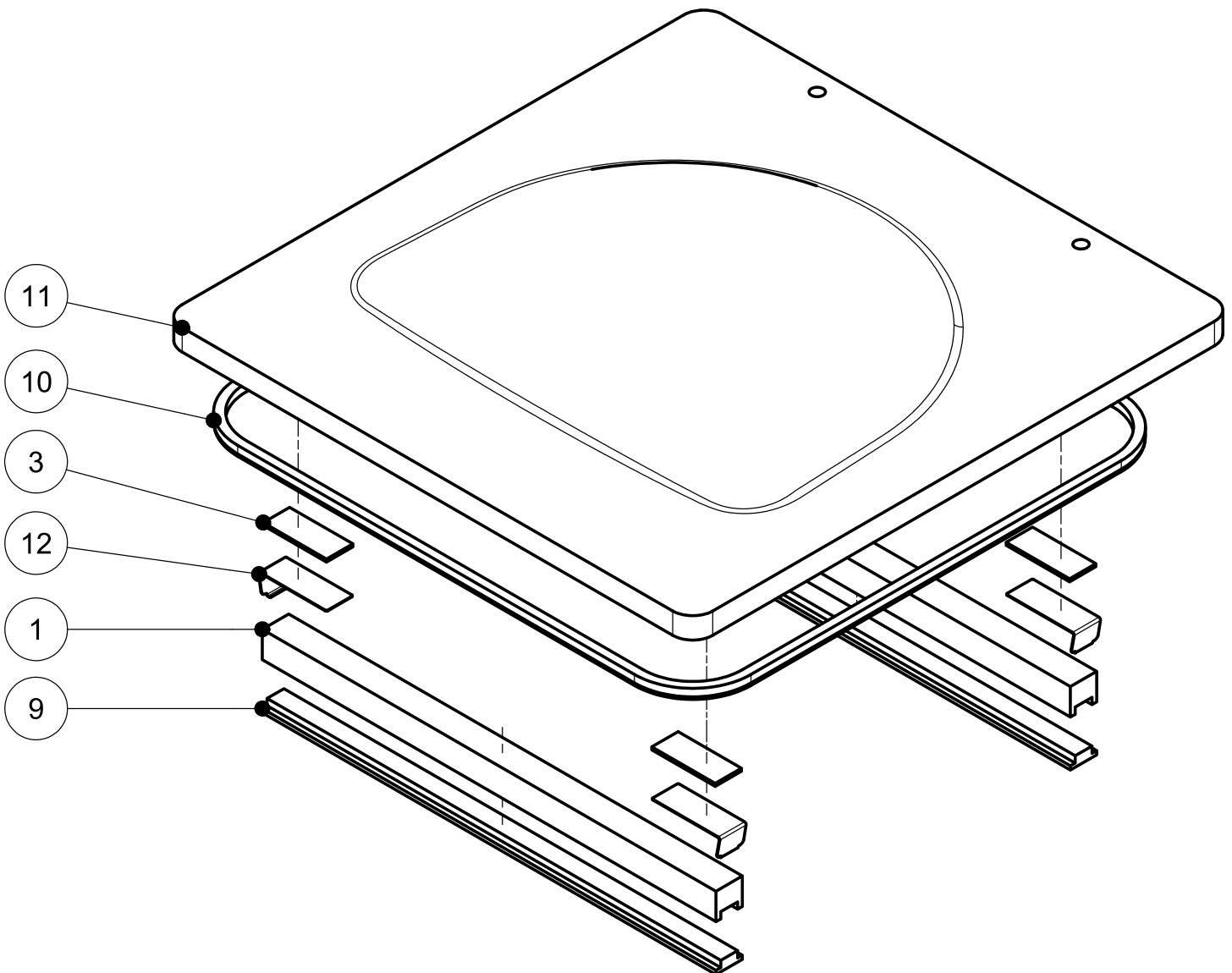

PARTS BREAKDOWN

ITEM	MODEL
59008	VP-NL-0016-SN
59009	VP-NL-0021-SN
59010	VP-NL-0016-LN

Hinge

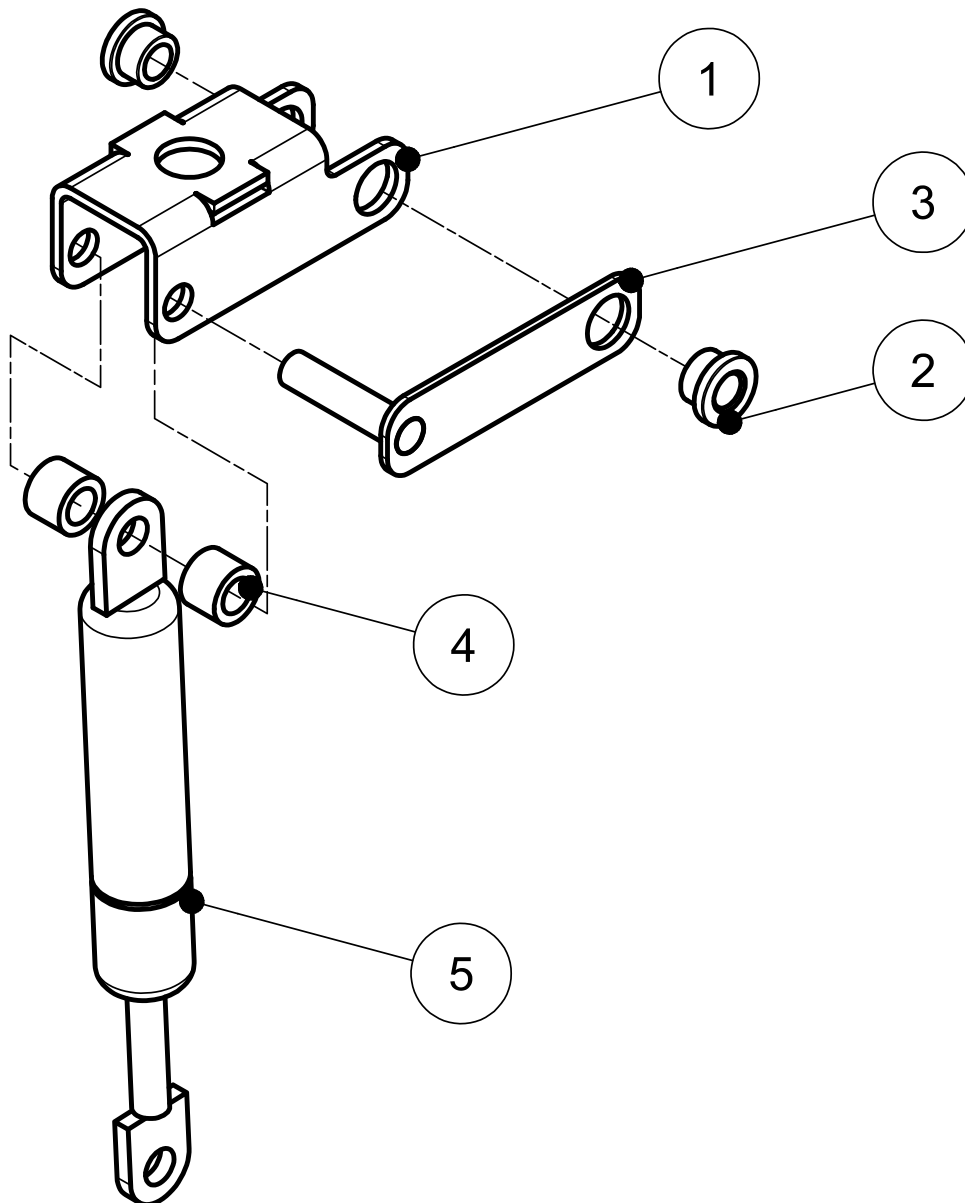

PARTS BREAKDOWN

ITEM	MODEL
59008	VP-NL-0016-SN
59009	VP-NL-0021-SN
59010	VP-NL-0016-LN

Air Valve

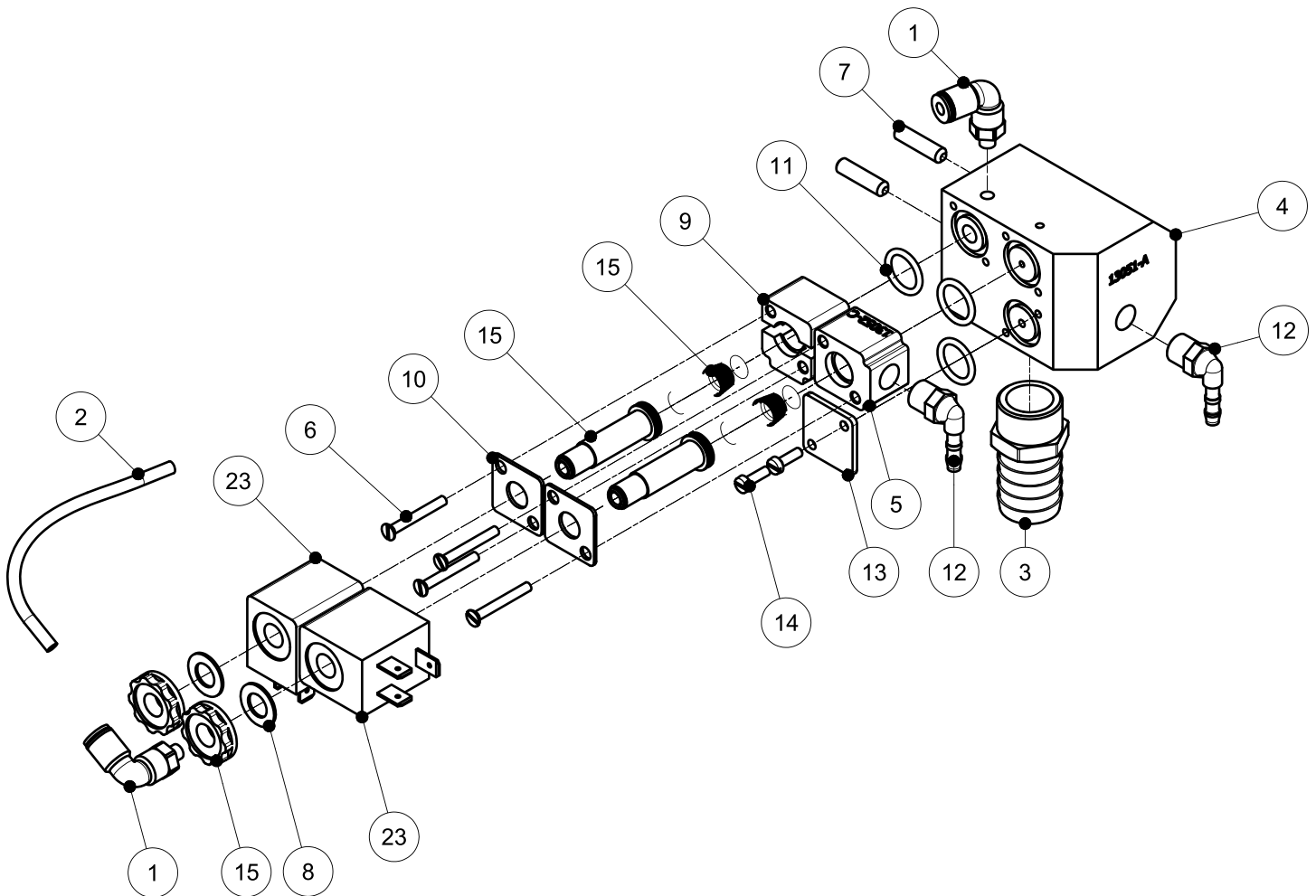

PARTS BREAKDOWN

ITEM	MODEL
59008	VP-NL-0016-SN
59009	VP-NL-0021-SN
59010	VP-NL-0016-LN

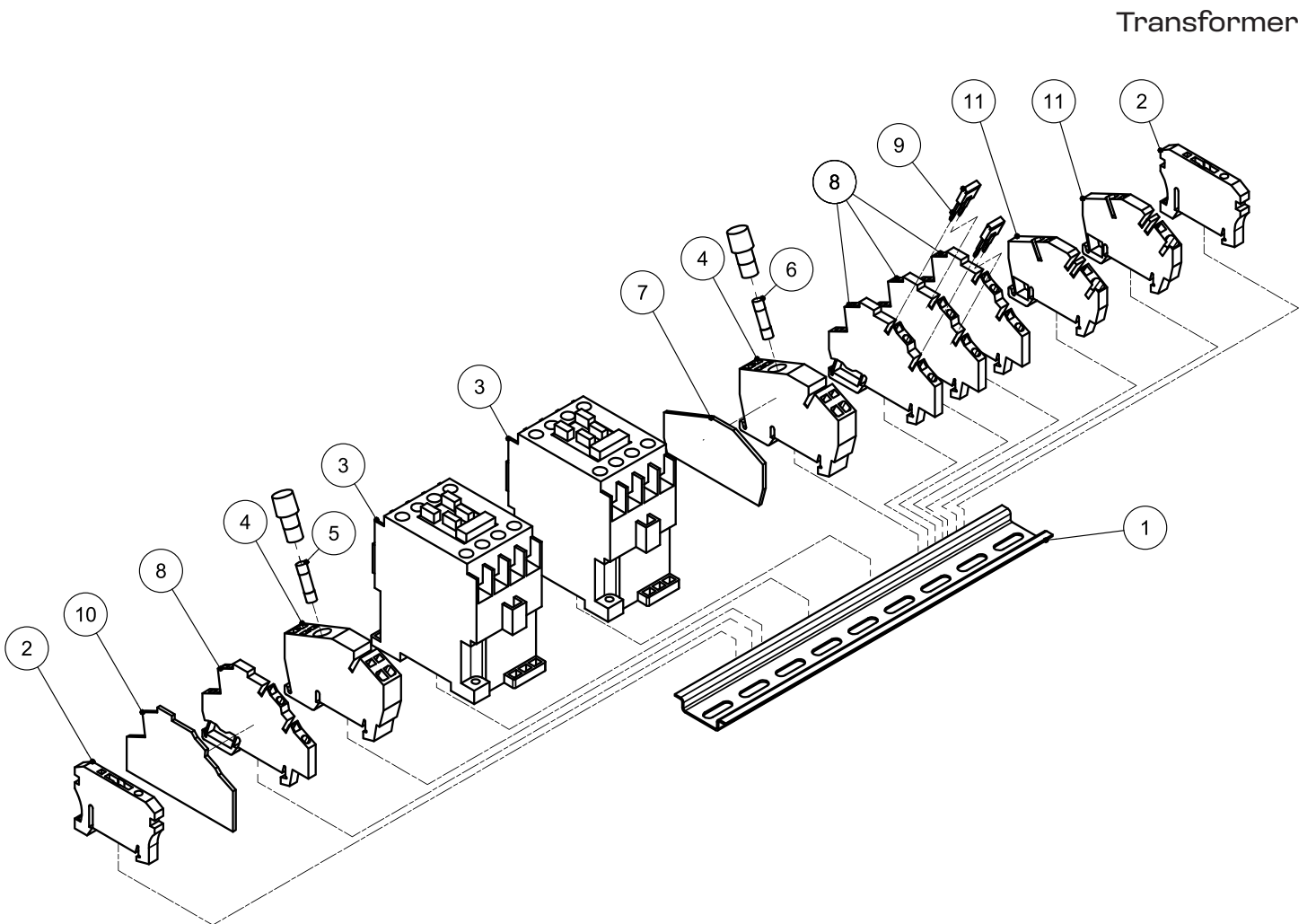

PARTS BREAKDOWN

ITEM	MODEL
59008	VP-NL-0016-SN
59009	VP-NL-0021-SN
59010	VP-NL-0016-LN

Control Panel

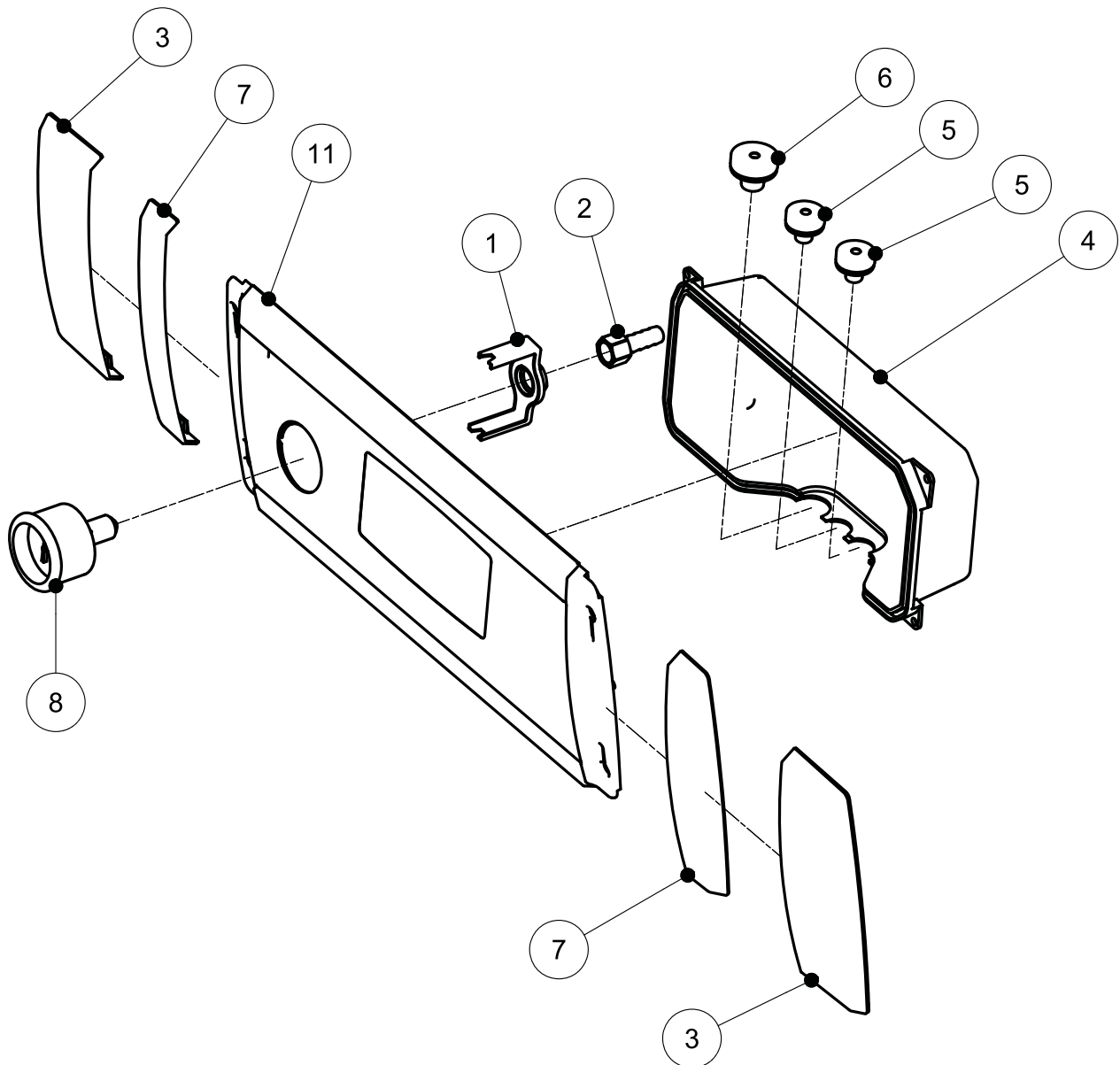

PARTS BREAKDOWN

ITEM	MODEL
59008	VP-NL-0016-SN
59009	VP-NL-0021-SN
59010	VP-NL-0016-LN

Overall

Item No.	Description	Position	Item No.	Description	Position	Item No.	Description	Position
AI880	Pump 016 for 59008, 59009, 59010	2A	27796	Sticker Oil for 59008, 59009, 59010	19	27789	Slott.Rais.Counter.Head Screw M4x10 DIN7985 A2 for 59008, 59009, 59010	35
AC927	Vac Pump 021-336 110/115-1-60 for 59008, 59009, 59010	2B	27794	Sticker Machine Type for 59008, 59009, 59010	20	65836	Hucknagel Magna-Lok MGLP-B6-4 for 59008, 59009, 59010	36
35039	Y Connecting Piece 6mm for 59008, 59009, 59010	4	65834	Vibration Absorber D=25 H=17 M6x10 for 59008, 59009, 59010	21	35041	Hose Clip Klemfa 12.8x14.8mm for 59008, 59009, 59010	37
27827	Flat Washer M10 D9021 A2 for 59008, 59009, 59010	5	65854	T4 Box for 59008, 59009, 59010	22	35219	Flat Washer M8 D9021 A2 for 59008, 59009, 59010	39
27791	Net Entree Male Snap-In STF42 for 59008, 59009, 59010	6	65855	T4 Bottom Plate for 59008, 59009, 59010	23	35220	Hexagon Screw M8x10 DIN933 A2 for 59008, 59009, 59010	40
AI882	Thermal Fuse 6A for 59008, 59009, 59010	7A	65856	T4 Rear Wall for 59008, 59009, 59010	24	65839	M6x16 Hexagon Socket Set Screw DIN 916 for 59008, 59009, 59010	41
30022	Thermal Fuse 8A for 59008, 59009, 59010	7B	65857	T4 Lid Closure for 59008, 59009, 59010	25	27786	Flat Washer M6 D9021 A2 for 59008, 59009, 59010	42
35074	Thermal Fuse 10A for 59008, 59009, 59010	7C	AI563	Filler Plate T4 Bottom for 59008, 59009, 59010	26	35978	Hexagon Nut M10 DIN934 A2 for 59008, 59009, 59010	43
65748	Hose Bill G1-2x19mm OU. for 59008, 59009, 59010	8	AI564	Filler Plate T4 Top for 59008, 59009, 59010	27	27795	Sticker Tension Triangle for 59008, 59009, 59010	44
65740	Cap Small Holder 04-Control for 59008, 59009, 59010	10	65845	M10x35 Hex-Head Bolt Din 933 for 59008, 59009, 59010	28	35224	Sticker 98x65 Yellow for 59008, 59009, 59010	45
35285	Valve 2/2 MA-222-003-P27-SAH 24 for 59008, 59009, 59010	12	65749	M6 Hex Nut Din 985 for 59008, 59009, 59010	29	35223	Sticker 19x38 Yellow for 59008, 59009, 59010	46
35207	Brass Hose Coupling 1/8x6 Ext. for 59008, 59009, 59010	13	30005	Hexagon Screw M6x12 DIN933 A2 for 59008, 59009, 59010	30	65862	T4-21M3 Pump Hose for 59008, 59009, 59010	47A
65853	T-Piece G 1 8 BI for 59008, 59009, 59010	14	65860	Hinge Adjustment Plate 6mm AS for 59008, 59009, 59010	31	65863	T4-16M3 Pump Hose for 59008, 59009, 59010	47B
35204	Elbow 1/8 Int/Ext Brass for 59008, 59009, 59010	15	27782	Hexagon Flangenut M5 DIN6923 A2 for 59008, 59009, 59010	32	27835	Hose Clip ABA 15-24mm for 59008, 59009, 59010	48
35205	Brass Double Nipple 1/8 for 59008, 59009, 59010	16	65837	Din Rail C 1 Fase (1-Program) for 59008, 59009, 59010	34A	63995	Seal Bar TS-3-420 for 59008, 59009, 59010	51A
65846	Elma Cover Knob 040-3020 Black for 59008, 59009, 59010	17	65861	Din Rail E 1 Fase for 59008, 59009, 59010	34B	63994	Sealbeam DS/3/420 for 59008, 59009, 59010	51B
27781	Hexagon Flangenut M6 DIN6923 A2 for 59008, 59009, 59010	18	65838	Din Rail D 1 Fase for 59008, 59009, 59010	34C			

PARTS BREAKDOWN

ITEM	MODEL
59008	VP-NL-0016-SN
59009	VP-NL-0021-SN
59010	VP-NL-0016-LN

Vacuum Chamber

Item No.	Description	Position	Item No.	Description	Position	Item No.	Description	Position
AI883	T4-LL Vacuum Tray for 59008, 59009, 59010	1A	65776	Spring Washer DIN 127 - A4 for 59008, 59009, 59010	9	15775	Micro Switch MV3003L for 59008, 59009, 59010	19
AI884	T4 Vacuum Tray for 59008, 59009, 59010	1B	27830	Slotted Cheese Head Screw M4x6 A2 DIN84 for 59008, 59009, 59010	10	27822	Castle Washer M3 for 59008, 59009, 59010	20
AI885	T4 Vacuum Tray Gas for 59008, 59009, 59010	1C	65766	Pipe Nipple 1/8" x 6mm for 59008, 59009, 59010	11	27821	Slotted Cheese Head Screw M3x16 A2 DIN84 for 59008, 59009, 59010	21
65765	Extension Seal Cylinder 27mm for 59008, 59009, 59010	2	35407	Sealing Washer 0-1/4 for 59008, 59009, 59010	12	27810	Spring Ring with Cover 6mm / Shaft Locker with Cover for 59008, 59009, 59010	22
27799	Plastic Nut M24 for 59008, 59009, 59010	3	65771	Blindplug 1/4" Brass/Nickel for 59008, 59009, 59010	13	AI888	Hinge Shaft TT-03 for 59008, 59009, 59010	23
27381	O-Ring 34x3mm for 59008, 59009, 59010	4	35201	Elbow Brass for Gas Pipe for 59008, 59009, 59010	14	AI889	Hinge Part T4 Assembled for 59008, 59009, 59010	24
65774	Distance Ring 8mm for Seal Cilinder 90mm for 59008, 59009, 59010	5	30019	Hose Clip Klemfa 12.8x14.8mm for 59008, 59009, 59010	15	47339	Comb.Valve Model-I LV for 59008, 59009, 59010	25A
27832	O-Ring 40x3mm for 59008, 59009, 59010	6	AI887	T4 Hose Tree for 59008, 59009, 59010	16	AI890	Combination Valve Model-I SA/LV Assi. for 59008, 59009, 59010	25B
65764	Seal Cylinder 90mm Trough Shaft Assemb. for 59008, 59009, 59010	7	27823	Hexagon Nut M3 DIN934 A2 for 59008, 59009, 59010	17	35215	Cap Nut High M5 D1587 A2 for 59008, 59009, 59010	26
AI886	Seal Cord C1-12 for 59008, 59009, 59010	8	65772	M3 Washer DIN 9021 for 59008, 59009, 59010	18			

Seal Lid

Item No.	Description	Position	Item No.	Description	Position	Item No.	Description	Position
AI891	Silicone Holder T4 for 59008, 59009, 59010	1	35105	Sil.Profile Lid Gasket 8mm 60 SH/25MTR for 59008, 59009, 59010	10	AI892	Acrylic Tape Double Sided 25mm L=20mm for 59008, 59009, 59010	14
62750	Acrylic Tape Double Sided 25mm L60mm for 59008, 59009, 59010	3	45626	Lid for Cover T4 for 59008, 59009, 59010	11			
15842	Silicone T-Profile 40 Shore One Meter for 59008, 59009, 59010	9	65761	Clamping Spring Silicone Holder for 59008, 59009, 59010	12			

PARTS BREAKDOWN

ITEM	MODEL
59008	VP-NL-0016-SN
59009	VP-NL-0021-SN
59010	VP-NL-0016-LN

Hinge

Item No.	Description	Position	Item No.	Description	Position	Item No.	Description	Position
AI893	Hinge Part T3 for 59008, 59009, 59010	1	AI894	Locking Plate Hinge Part for 59008, 59009, 59010	3	AI895	Gas Spring 350N with Dyn. End Muffler for 59008, 59009, 59010	5
35093	Guide Bearing 6x9x6 for 59008, 59009, 59010	2	AI854	Spacer 6.2x10x7.5 for 59008, 59009, 59010	4			

Air Valve

Item No.	Description	Position	Item No.	Description	Position	Item No.	Description	Position
AI896	Knee M5 4mm for 59008, 59009, 59010	1	AI900	M5x20 Hexagon Socket Set Screw DIN 916 for 59008, 59009, 59010	7	AI904	Blind Plate Combi Valve for 59008, 59009, 59010	13
AI897	Compressed Air Hose 4x2 for 59008, 59009, 59010	2	AI901	M8 Crinkle Washer DIN 137 for 59008, 59009, 59010	8	AI905	M3x10 Slotted Cheese Head Screw DIN 84 for 59008, 59009, 59010	14
65748	Hose Bill G1-2x19mm OU. for 59008, 59009, 59010	3	AI902	6mm Adapter Valves Block for 59008, 59009, 59010	9	AI666	3-2 Armature Met 8mm Seal for 59008, 59009, 59010	15
AI898	Base Block Combination Valve Model-I for 59008, 59009, 59010	4	AI903	Clamp Plate Valve Luminaire for 59008, 59009, 59010	10	AH174	Coil 24VAC 50/60Hz 8.5VA for 59008, 59009, 59010	23
AI858	Adapter Valve 2.5mm for 59008, 59009, 59010	5	AI859	O-Ring 12x2mm for 59008, 59009, 59010	11			
AI899	M3x25 Countersunk Screw DIN 963 for 59008, 59009, 59010	6	35402	Square Hose Coupling 1/8x4 Ext. for 59008, 59009, 59010	12			

Transformer

Item No.	Description	Position	Item No.	Description	Position	Item No.	Description	Position
35319	Rail JMV35SL 9-Hole 220mm for 59008, 59009, 59010	1	35307	Fuse Keram.5x20 2.5A Delay for 59008, 59009, 59010	5	35688	Clamp Connector 2.5/2 for 59008, 59009, 59010	9
35305	End Fent for 59008, 59009, 59010	2	15818	Fuse 5x20 4A Slow for 59008, 59009, 59010	6	35323	End Plate Wire Connector for 59008, 59009, 59010	10
AI906	Contacter 3-Poles AC1 25A 230V 2,5KW 400V 4KW for 59008, 59009, 59010	3	65708	Locking Plate Zap ZDU 6-2 for 59008, 59009, 59010	7	AI907	Wire Clamp 4-2 2 AN for 59008, 59009, 59010	11
35306	Fuse Clamp 2.5-2/ZSI for 59008, 59009, 59010	4	35315	Double Clamp 2.5-2 for 59008, 59009, 59010	8			

PARTS BREAKDOWN

ITEM	MODEL
59008	VP-NL-0016-SN
59009	VP-NL-0021-SN
59010	VP-NL-0016-LN

Control Panel

Item No.	Description	Position	Item No.	Description	Position	Item No.	Description	Position
35579	Vacuum Meter 40mm for 59008, 59009, 59010	1	65754	Cover Protection 04-Control for 59008, 59009, 59010	4	65740	Cap Small Holder 04-Control for 59008, 59009, 59010	7
65752	Hose Coupling 1-4x8 BI MS for 59008, 59009, 59010	2	65755	Grommet 16mm (283 1600 599 99) for 59008, 59009, 59010	5	65757	Vacuum Meter 40mm 04-Series for 59008, 59009, 59010	8
65753	Cap Wide Holder 04-Control for 59008, 59009, 59010	3	65756	Grommet 20mm (283 1600 599 99) for 59008, 59009, 59010	6	AI908	Holder Large - PCB-HV Time for 59008, 59009, 59010	11

ELECTRICAL SCHEMATICS

ITEM	MODEL
59006	VP-NL-0004-SN
59007	VP-NL-0008-SN

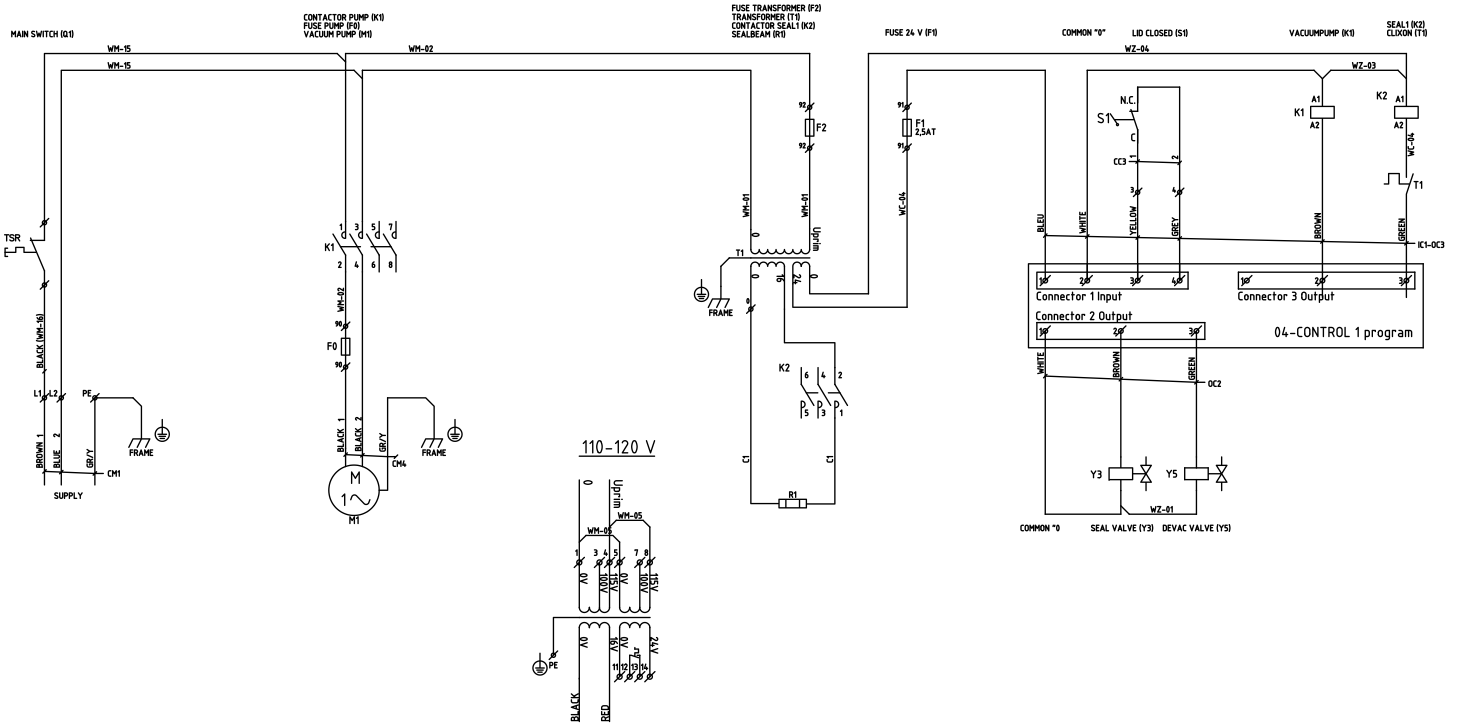

ELECTRICAL SCHEMATICS

ITEM	MODEL
59008	VP-NL-0016-SN
59009	VP-NL-0021-SN
59010	VP-NL-0016-LN

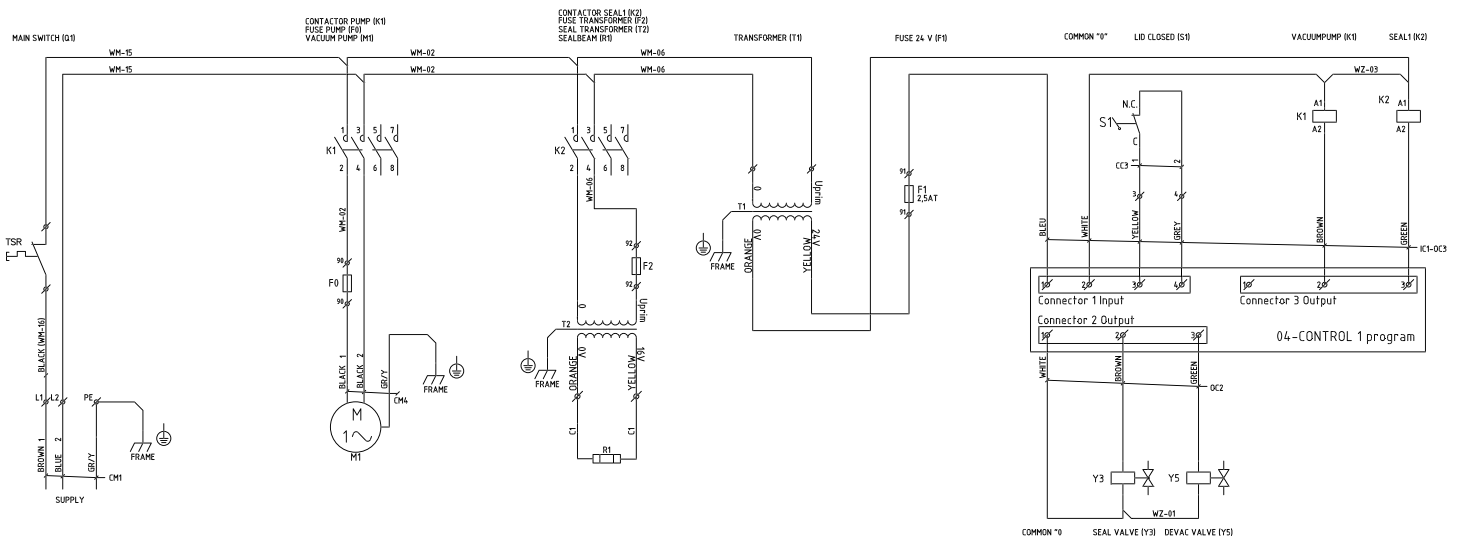

WARRANTY REGISTRATION

Thank you for purchasing an Trento product. To register your warranty for this product, complete the information below, tear off the card at the perforation and then send to the address specified below. You can also register online by visiting:

Merci d'avoir acheté un produit Trento. Pour enregistrer votre garantie pour ce produit, complétez les informations ci-dessous, détachez la carte au niveau de la perforation, puis l'envoyer à l'adresse spécifiée ci-dessous. Vous pouvez également vous inscrire en ligne en visitant:

Gracias por comprar un producto Trento usted. Para registrar su garantía para este producto, complete la información a continuación, cortar la tarjeta en la perforación y luego enviarlo a la dirección indicada a continuación. También puede registrarse en línea en:

<https://omcan.com/warranty-registration/>

For mailing in Canada

Pour postale au Canada

Por correo en Canadá

TRENTO

PRODUCT WARRANTY REGISTRATION

3115 Pepper Mill Court,
Mississauga, Ontario
Canada, L5L 4X5

For mailing in the US

Pour diffusion aux États-Unis

Por correo en los EE.UU.

TRENTO

PRODUCT WARRANTY REGISTRATION

4450 Witmer Industrial Estates, Unit 4,
Niagara Falls, New York
USA, 14305

or email to: trentoservice@trentoequipment.com



Purchaser's Information

Name: _____

Address: _____

City: _____ Province or State: _____ Postal or Zip: _____

Country: _____

Dealer from which Purchased: _____

Dealer City: _____ Dealer Province or State: _____

Invoice: _____

Model Name: _____ Model Number: _____

Machine Description: _____

Date of Purchase (MM/DD/YYYY): _____

Would you like to extend the warranty? Yes No

Company Name: _____

Telephone: _____

Email Address: _____

Type of Company:

Restaurant Bakery Deli

Butcher Supermarket Caterer

Institution (*specify*): _____

Other (*specify*): _____

Serial Number: _____

Date of Installation (MM/DD/YYYY): _____

Thank you for choosing Trento | Merci d'avoir choisi Trento | Gracias por elegir Trento

TRENTO

ELEVATING CULINARY EXCELLENCE

TRENTO IS A SIGNATURE LINE OF
PROFESSIONAL RESTAURANT EQUIPMENT
FROM OMCAN OFFERING PREMIUM EUROPEAN
BRANDS TO THE NORTH AMERICAN MARKET.

Thank you for your purchase!



Follow us on social media
@trentoequipment

